

# ashirvad

by aliaxis

## UNDERGROUND DRAINAGE SYSTEM

SMART AND EFFICIENT DRAINAGE  
TECHNICAL MANUAL



Inspection Chamber

WARRANTY APPLICABLE ONLY IF ASHIRVAD PIPES,  
FITTINGS & SOLVENT CEMENT OR LUBRICANT ARE USED

**REDI**  
TECHNOLOGY FROM ITALY



# Smart and efficient drainage system

Ashirvad underground system is a complete solution for drainage and sewerage application. Being 100% watertight, it is free from ingress and seepage of water and hence considered to be most hygienic. Unlike conventional drainage products, it is free from pollution of underground water, soil or ill effects on building foundations.

The system has the following benefits:



Ease of installation



Smooth internal finish



Dependable leak proof joints



Wide range of products



Commercially astute



ashirvad



# Index

## 01

About Ashirvad	09
Certifications	10
About Aliaxis	11
10 Assurances	16

## 02

About uPVC	19
About Foam Core	21

## 03

Why Ashirvad Underground Drainage System?	23
Why only Pushfit?	24
Technical Specifications	25
Ring Stiffness	28

## 04

Quality Control Procedures at Ashirvad	29
Inspection Chambers	31
Manholes	32
Speciality Fittings	33
Surface Drainage	36
Applications of Underground Drainage System	39
Handling and Storage	40

## 05

Installation Guide Pushfit	42
Trench Excavation	43
Underground Fittings - Technical Details	44
Inspection Chambers - Technical Details	46
Inspection Chambers and Manholes - Technical Details	49
Ashirvad Underground Drainage System Limited Warranty	51

Water - In all its forms,  
a precious gift to life around,  
ever flowing, never stopping,  
always forward bound.

From the sky, from the rivers,  
from the lakes around  
Bringing joy, bringing cheer  
abundant & profound  
Water, water everywhere,  
happiness abound

“Khushiyon ke rang - paani ke sang”

be **water happy**<sup>TM</sup>



**ashirvad**

160MM O.D. S.W.R. SILENT PLUS PIPES 10dB/2LPS TESTED TO EN 14366.

**ashirvad**

110MM O.D. S.W.R. SILENT PIPES 13dB/2LPS TESTED TO EN 14366.

**+**

**ashirvad**

SDR 11

**FLOWGUARD™ PLUS**

**+**

**ashirvad**

SDR 11

**FLOWGUARD™ PLUS**

**ashirvad**

AQUALIFE™ (DN 20mm) 3/4" uPVC ASTM - D - 1785 SCHD 40 LEAD FREE

**ashirvad**

SUPER HEAVY CLASS

**ashirvad**

STANDARD CLASS



# About Ashirvad

Ashirvad an Aliaxis group company, setup its Bengaluru unit in 1998 and is a wholly owned company of Aliaxis group. Aliaxis group is a global leading manufacturer and distributor of plastic fluid handling systems used in residential, commercial and industrial buildings. Aliaxis, headquartered in Brussels and is present over 45 countries with more than 100 manufacturing and commercial entities, employs over 16,000 people and generates more than 3 billion Euro ( ₹ 21, 600 crores approx) in annual sales.

Ashirvad has always been relentless in its commitment to quality and services. Ashirvad pipes is a leading manufacturer and supplier of CPVC, uPVC, SWR plumbing systems and also the pioneer in designing and manufacturing of uPVC column pipes, which are used in the erection of submersible borehole pumps. Today Ashirvad Pipes is the world's largest manufacturer of uPVC column pipes and successfully exporting to 40+ countries. The CPVC Hot and Cold plumbing system is manufactured in collaboration with Lubrizol, USA.

Ashirvad is an ISO 9001:2015, ISO 14001:2015 and ISO 45001:2018 certified company with a constant endeavour towards achieving the highest level of customer satisfaction.

Ashirvad, with a determination to be a one-stop-shop for Plumbing, Agriculture, Sanitary, High-rise and Fire Safety solutions, has recently expanded its product range and successfully introduced Agri Pipe, Casing Pipe, BlazeMaster® Pipes & Fittings by Ashirvad.

## Capabilities:

- Manufacturing capacity of more than 2,00,000 MT per annum
- Total factory area of 50 acres
- 500+ Strong Sales & marketing staff across India
- Strong team of 205 at corporate office
- Over 4,500 manufacturing workforce
- 17 warehouses, 1,100 distributors, 53,000 dealers across India
- Exporting Column Pipes to more than 40 countries
- 2 factories in Bengaluru and another one in Bhiwadi (Rajasthan) near Delhi



**In 2007, Ashirvad won the National Award for "OUTSTANDING ENTREPRENEURSHIP IN MEDIUM ENTERPRISES"**

The award was presented by the Prime Minister of India.



**WCRC Leaders Summit - 2014**

Ashirvad Pipes

**"One Of The 100 Fastest Growing Marketing Brands In Asia"**

(Evaluated and selected by KPMG)  
The Global Audit Firm



**Construction Industry Database (CIDC) - 2015** Has been enlisted as an **Approved Vendor** for providing the following Services / Products  
Manufacturing of  
CPVC & uPVC Pipes & Fittings

# Certifications

**intertek**  
Total Quality Assured

## CERTIFICATE OF REGISTRATION

**This is to certify that the management system of**  
**Ashirvad Pipes Pvt. Ltd.**

Site 1: Plot No. 4-B, 26 & 26 B Attibele Industrial Area, Hosur Road, Bengaluru - 562107, Karnataka, India  
 Site 2: Plot No. 27-P, 28-P, 29 & 30, Bommasandra-Jigani Link Road, Industrial Area, Jigani Hobli, Anekal Taluk, Bangalore - 560105, Karnataka, India  
 Site 3: Plot No. SP1-177 & 178, Kahrani Industrial Area, Bhiwadi Extension, Dis. Alwar - 301019, Rajasthan, India  
**has been registered by Intertek as conforming to the requirements of**  
**ISO 45001:2018**

OHSAS 18001:2007 certified from 20 July 2017 to 27 February 2019.

**The management system is applicable to:**  
 Manufacture and Supply of uPVC & cPVC Pipes and Fittings and Solvent Cement for Industrial, Domestic, Agriculture, Sewage Applications.

**Certificate Number:** 0087730  
**Initial Certification Date:** 20 July 2017  
**Date of Certification Decision:** 27 February 2019  
**Issuing Date:** 28 February 2019  
**Valid Until:** 26 February 2022



**Calin Moldovean**  
 President, Business Assurance  
 Intertek Certification Limited  
 10A Victory Park, Victory Road  
 Derby DE24 8ZF, United Kingdom

Intertek Certification Limited is a UKAS accredited body under schedule of accreditation no. 014.



In the issuance of this certificate, Intertek assumes no liability to any party other than to the Client, and then only in accordance with the agreed upon Certification Agreement. This certificate's validity is subject to the organization maintaining their system in accordance with Intertek's requirements for systems certification. Validity may be confirmed via email at [certificate.validation@intertek.com](mailto:certificate.validation@intertek.com) or by scanning the code to the right with a smartphone. The certificate remains the property of Intertek, to whom it must be returned upon request.

CT-ISO45001-UKAS-EN-44-02.aug.18

**intertek**  
Total Quality Assured

## CERTIFICATE OF REGISTRATION

**This is to certify that the management system of:**  
**Ashirvad Pipes Pvt. Ltd.**

Site 1: Plot No. 4-B, 26 & 26 B Attibele Industrial Area, Hosur Road, Bengaluru - 562107, Karnataka, India  
 Site 2: Plot No. 27-P, 28-P, 29 & 30, Bommasandra-Jigani Link Road, Industrial Area, Jigani Hobli, Anekal Taluk, Bangalore - 560105, Karnataka, India  
 Site 3: Plot No. SP1-177 & 178, Kahrani Industrial Area, Bhiwadi Extension, Dis. Alwar - 301019, Rajasthan, India  
**has been registered by Intertek as conforming to the requirements of:**  
**ISO 9001:2015**

**The management system is applicable to:**  
 Manufacture and Supply of uPVC & cPVC Pipes and Fittings and Solvent Cement for Industrial, Domestic, Agriculture, Sewage Applications.

**Certificate Number:** 0087727  
**Initial Certification Date:** 10 April 2003  
**Date of Certification Decision:** 27 February 2019  
**Issuing Date:** 28 February 2019  
**Valid Until:** 26 February 2022



**Calin Moldovean**  
 President Business Assurance  
 Intertek Certification Limited, 10A Victory Park,  
 Victory Road, Derby DE24 8ZF, United Kingdom

Intertek Certification Limited is a UKAS accredited body under schedule of accreditation no. 014.

In the issuance of this certificate, Intertek assumes no liability to any party other than to the Client, and then only in accordance with the agreed upon Certification Agreement. This certificate's validity is subject to the organization maintaining their system in accordance with Intertek's requirements for systems certification. Validity may be confirmed via email at [certificate.validation@intertek.com](mailto:certificate.validation@intertek.com) or by scanning the code to the right with a smartphone. The certificate remains the property of Intertek, to whom it must be returned upon request.

CT-ISO 9001:2015-UKAS-EN-44-P-13.dec.17

**intertek**  
Total Quality Assured

## CERTIFICATE OF REGISTRATION

**This is to certify that the management system of:**  
**Ashirvad Pipes Pvt. Ltd.**

Site 1: Plot No. 4-B, 26 & 26 B Attibele Industrial Area, Hosur Road, Bengaluru - 562107, Karnataka, India  
 Site 2: Plot No. 27-P, 28-P, 29 & 30, Bommasandra-Jigani Link Road, Industrial Area, Jigani Hobli, Anekal Taluk, Bangalore - 560105, Karnataka, India  
 Site 3: Plot No. SP1-177 & 178, Kahrani Industrial Area, Bhiwadi Extension, Dis. Alwar - 301019, Rajasthan, India  
**has been registered by Intertek as conforming to the requirements of:**  
**ISO 14001:2015**

**The management system is applicable to:**  
 Manufacture and Supply of uPVC & cPVC Pipes and Fittings and Solvent Cement for Industrial, Domestic, Agriculture, Sewage Applications.

**Certificate Number:** 0087727  
**Initial Certification Date:** 20 July 2017  
**Date of Certification Decision:** 27 February 2019  
**Issuing Date:** 28 February 2019  
**Valid Until:** 26 February 2022



**Calin Moldovean**  
 President Business Assurance  
 Intertek Certification Limited, 10A Victory Park,  
 Victory Road, Derby DE24 8ZF, United Kingdom

Intertek Certification Limited is a UKAS accredited body under schedule of accreditation no. 014.

In the issuance of this certificate, Intertek assumes no liability to any party other than to the Client, and then only in accordance with the agreed upon Certification Agreement. This certificate's validity is subject to the organization maintaining their system in accordance with Intertek's requirements for systems certification. Validity may be confirmed via email at [certificate.validation@intertek.com](mailto:certificate.validation@intertek.com) or by scanning the code to the right with a smartphone. The certificate remains the property of Intertek, to whom it must be returned upon request.

CT-ISO 14001:2015-UKAS-EN-44-P-13.dec.17

# About Aliaxis



Aliaxis group is a leading global manufacturer and distributor of plastic fluid handling systems used in residential, commercial and industrial buildings.

Head quartered in Brussels, Belgium. Aliaxis is present in over 45 countries, has more than 100 manufacturing and commercial entities and employs over 16,000 people.

Aliaxis leverages local and global knowledge of the industry as well as regulations and building habits to provide consistently excellent customer service through distribution partners to builders, installers, infrastructure contractors and others. The group is in the Indian plumbing and sanitary market through a partnership with Ashirvad Pipes since 2013.

## Aliaxis at a glance



**€ 3.1 billion**

Revenue



**120+**

Distribution centres



**1.400+**

Injection machines



**16.000+**

Colleagues



**45+**

Countries



**600+**

Extruders



**€ 87 million**

Capex



**80+**

Manufacturing sites



**10**

Commercial brands

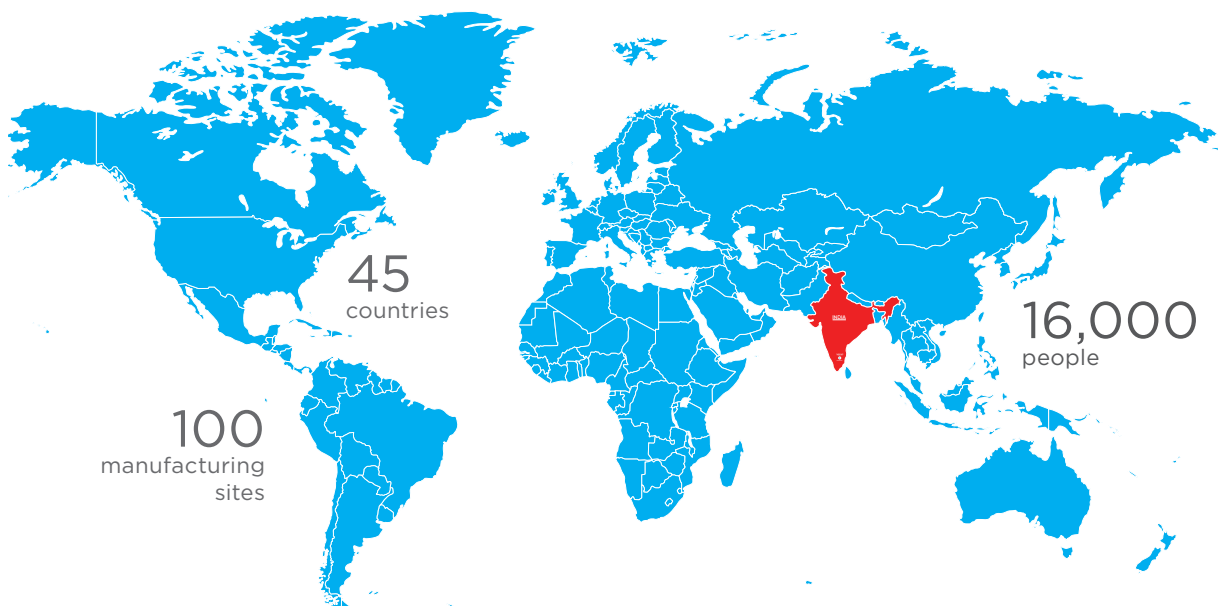





Ashirvad production plant



Injection Moulding Facility

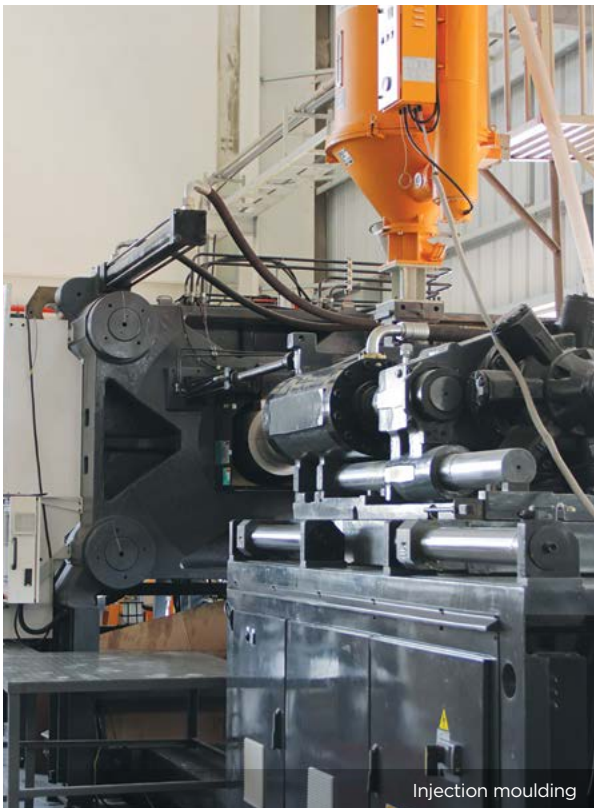

# 10 ASSURANCES

#01

STATE OF THE ART  
MANUFACTURING FACILITIES

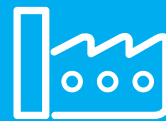

#02

ADVANCED MACHINERY  
FOR SUPERIOR QUALITY

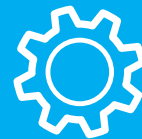

#03

ADVANCED MATERIAL  
HANDLING SYSTEMS

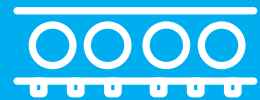

#04

100% INCOMING RAW  
MATERIAL INSPECTION

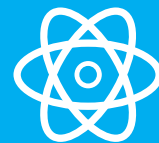

#05

HIGH DIMENSIONAL ACCURACY  
TO MAINTAIN QUALITY OF  
EACH PIECE, TO ENSURE  
A DEFECT FREE SYSTEM





Ashirvad's stringent quality checks ensure premium products and maximum customer satisfaction

#06

STRINGENT QUALITY  
CHECKS AT EVERY LEVEL  
OF PRODUCTION

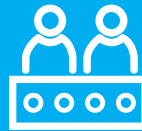

#07

CHECKING OF GROOVES  
AND RINGS



#08

EVERY BATCH OF  
PRODUCTS LAB TESTED



#09

CONSTANT INNOVATION IN  
DESIGN FOR BETTER QUALITY



#10

REGULAR EXTERNAL LAB  
TESTING OF PRODUCTS  
IN INDIA



A multi-story building under construction, showing concrete frames and wooden scaffolding. A large blue semi-transparent overlay covers the middle portion of the image, containing white text. The background shows a clear sky and some construction materials on the ground.

# UNDERGROUND DRAINAGE SYSTEM

Ashirvad's underground drainage system is intended to carry soil, waste, rainwater or industrial effluent system from building to roadside sewers or drains and from there to waste treatment plant or point of discharge.

# About uPVC

uPVC is a versatile plastic material that has been used for plumbing and drainage systems for many decades. Ease of processing, smooth interiors as well as rigid pipes and fittings that can be manufactured with uPVC have been instrumental in its wide spread usage for such applications. Below are common properties of uPVC that are given for reference only.

## Physical Properties

Density [g/cm <sup>3</sup> ]	1.3 - 1.45
Thermal conductivity [w/(m.k)]	0.14 - 0.28
Yield strength [MPa]	31 - 60
Young's modulus [psi]	4,90,000
Flexural strength (yield) [psi]	10,500
Compression strength [psi]	9,500
Coefficient of thermal expansion (linear) [mm (mm''c)]	$5 \times 10^{-5}$
Vicat B [°c]	65 - 100
Resistivity [Qm]	$10^{16}$
Surface resistivity [Q]	$10^{13} - 10^{14}$



# About Foam Core

## Defining underground drainage

Underground drainage system comprises of pipes, fittings and accessories used to conduct household sewage, rainwater or Industrial effluent. Most commonly seen application is in between houses or buildings to municipal sewers. It is a non pressure application system and as such can be comprised from different materials such as PVC, HDPE, clay, concrete or fibre glass. The Ashirvad product is made of uPVC for the following reasons:

- Strong and light weight
- Chemical stability
- Leak proof joints
- Maximum flow rate
- Good insulator
- Biocompatibility
- Resistance to chemical stress cracking

Underground drainage system pipes can be obtained in various constructions such as solid wall and structured wall. Ashirvad has chosen to supply pipes produced in 3 layers with the middle layer comprised of uPVC foam to enhance modulus and reduce weight.

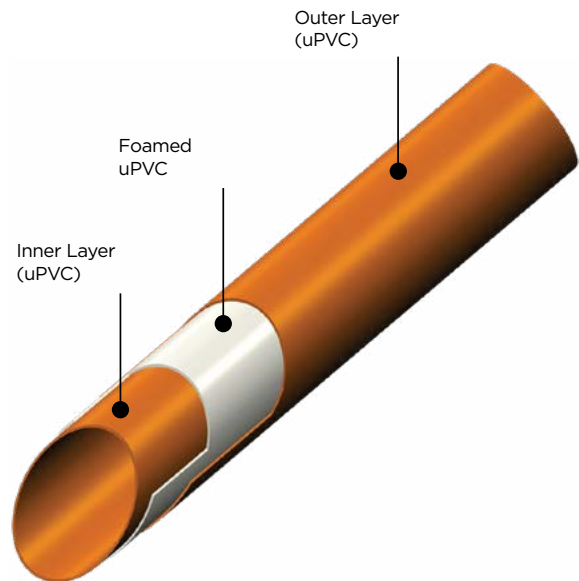

## Advantages of Foam Core

Foam core pipes are basically multi- layer pipes having outer and inner layers of conventional uPVC and middle layer of foamed uPVC. Outer and inner layers are designed to take the load as well as provide chemical resistance while middle layer of foamed uPVC gives rigidity and maintains the shape of the pipe under load. Due to its ability of absorbing the load, foamcore pipes are most suitable for underground drainage systems, where soil exerts a lot of pressure on pipe surfaces.

- Light weight and strong
- Dampening of vibrations and noise level
- High impact strength
- Wide temperature range
- Thermal insulation
- Water ingress prevention (resulting from filling of hollow space)

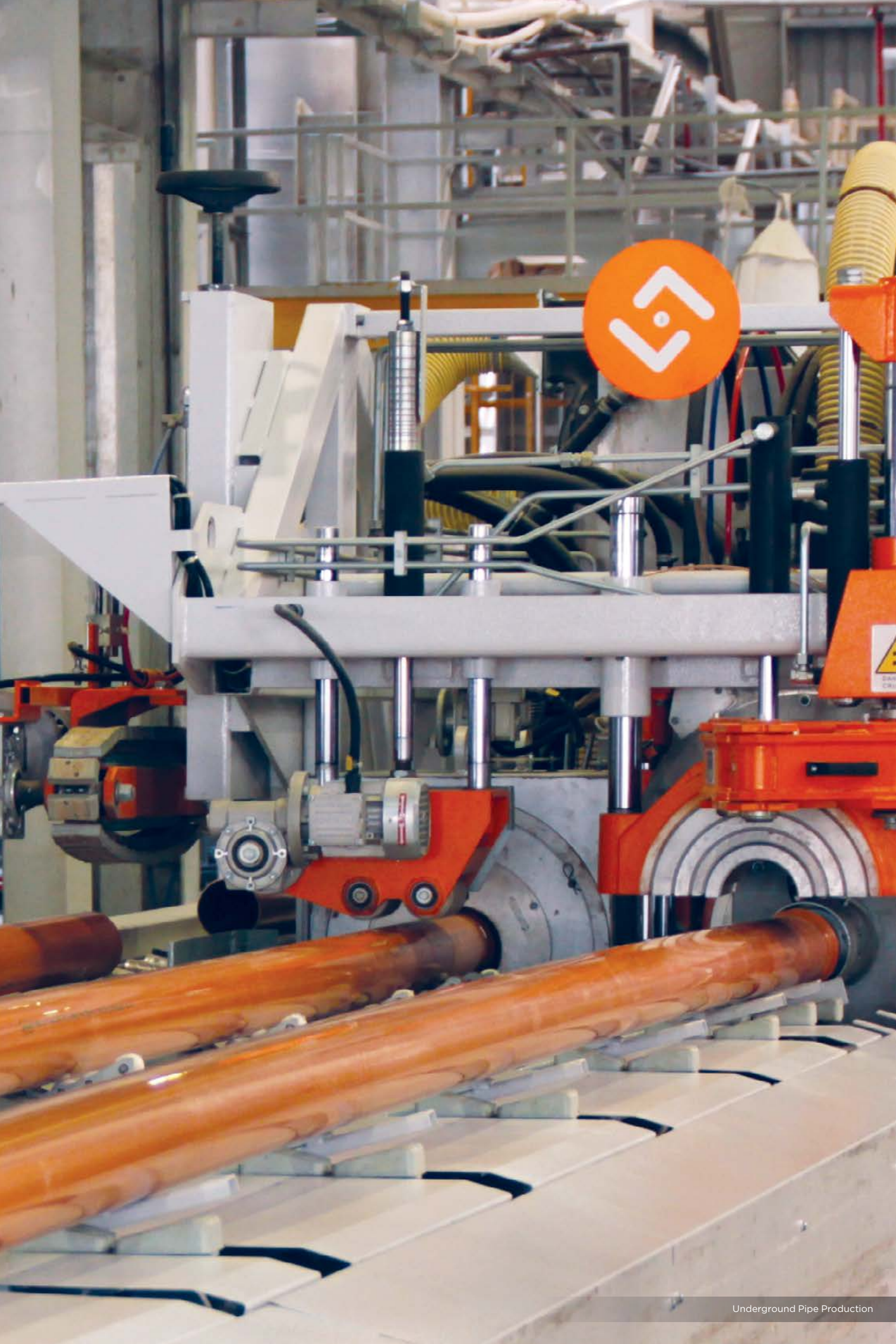

# Why Ashirvad Underground Drainage System?

Ashirvad offers an industry leading range of underground and surface drainage systems. These systems offer unparalleled installation options with high quality finish, superior dimensional accuracy and stability and are suitable for all types of commercial and domestic installations.

These pipes are extruded on state-of-the-art extruders and are socketed on inline belling machines. The fittings are manufactured in collapsible core moulds to ensure straight sharp finish of the grooves for higher dimensional accuracy of the product which finally ensures the highest degree of dimensional accuracy and product strength.

Ashirvad underground drainage systems, therefore, offer unrivalled strength and product finish that provides a leak proof, maintenance free and long lasting solution to the customer. All this is backed by extensive technical research to support all aspects of design and installation.

Ashirvad underground drainage pipes are available in 110 mm to 315 mm in Pushfit and Solfit jointing methods with different stiffness classes mainly categorised as SN2, SN4 and SN8.

- 110 mm with stiffness class SN4 and SN8
- 160 mm, 200 mm, 250 mm and 315 mm with stiffness class SN2, SN4 and SN8

## Wide range of pipes and fittings

Sizes available for Pipes and fittings in Pushfit and Solfit – 110, 160, 200, 250 and 315 mm.

## Under technical collaboration from REDI\*

Ashirvad under technical collaboration from REDI made it possible to have wide range of products in underground drainage range.

## Special fittings from REDI\*

Special fittings such as large dia non return valves, easy clips, mechanical saddles, swivel and few higher diameter fittings are imported from REDI.

## Fully analyzed raw materials

The raw materials used for manufacturing the products are fully analyzed and procured with utmost care to deliver high quality products to the customers.

## Best manufacturing standards

The pipes are extruded on state-of-the-art extruders and are socketed on online belling machines. The fittings are manufactured in collapsible core moulds to ensure straight sharp finish of the grooves for higher dimensional accuracy of the product which finally ensures the highest degree of dimensional accuracy and product strength.

## Wide distribution network

Ashirvad has a wide distribution network throughout the country which makes it possible to find our products in local shops too.

## Rodent proof

Smooth surfaces and the rigidity of uPVC are hindrance for rodents from damaging the system.

### FEATURES AND BENEFITS OF ASHIRVAD UNDERGROUND DRAINAGE SYSTEM

- Light weight and strong
- Wide range and compatibility
- Easy to install
- Maximum flow rate
- Longer service life
- Chemical and corrosion resistance
- Non toxic and non conductor
- Non flammable and environmental friendliness
- Noise free

## REDI

\*REDI (Italy) is active since 1960 and are leaders in the management of waste water system as well as ventilation in Europe.

# Why only Pushfit?

New moulding technology has made it feasible to produce bimoulded rubber rings that are more dependable and do not slip out of the groove during installation. This requires no threading or solvent cementing. The spigot end is held firmly in the socket with the help of the **Brown Seal™**. It ensures a leak proof joint and can withstand high pressure flow. This system is made in high tech, new generation machines and offers unrivalled performance, strength and finish.

The advanced **Brown Seal™** enables the joints to not only withstand high pressure and provide leak proof joints but also accommodates the thermal expansion and contraction of plastic. Since the joint is not fixed by solvent cement, it can be reopened after installation to realign, change or adjust the pipe/fitting.



## THERMAL EXPANSION

uPVC has a coefficient of expansion of approximately 0.06mm/m/°C. Consequently a 2m length of soil or waste pipe will expand by 2.4 mm for a 20°C rise in temperature. This expansion is taken into consideration in the design of systems and components, and must be accommodated when installing. It is important that this movement be allowed by including an expansion gap at ring seal joints. The spigot should be pushed fully into the ring seal socket, marked at the socket face, and then withdrawn by 10 mm. A subsequent check should be made to ensure that the expansion gap is not lost during further installation work.



Quick, easy and convenient installation



Corrosion and abrasion resistance



Smooth inner finish



Tough and reliable



Cost effective



# Technical Specifications for UGD Pushfit System

Ashirvad Underground drainage system pipes are manufactured as per IS 16098 (Part 1) : 2013 standard and fittings are manufactured as per EN 1401-1:2009 (SDR 41) standard in sizes ranging from 110, 160, 200, 250 and 315 mm. This system comes with a pre-fitted rubber (**Brown Seal™**) in the groove that ensures a leak proof joint. The system is joined by simply pushing the spigot end into the socket end.

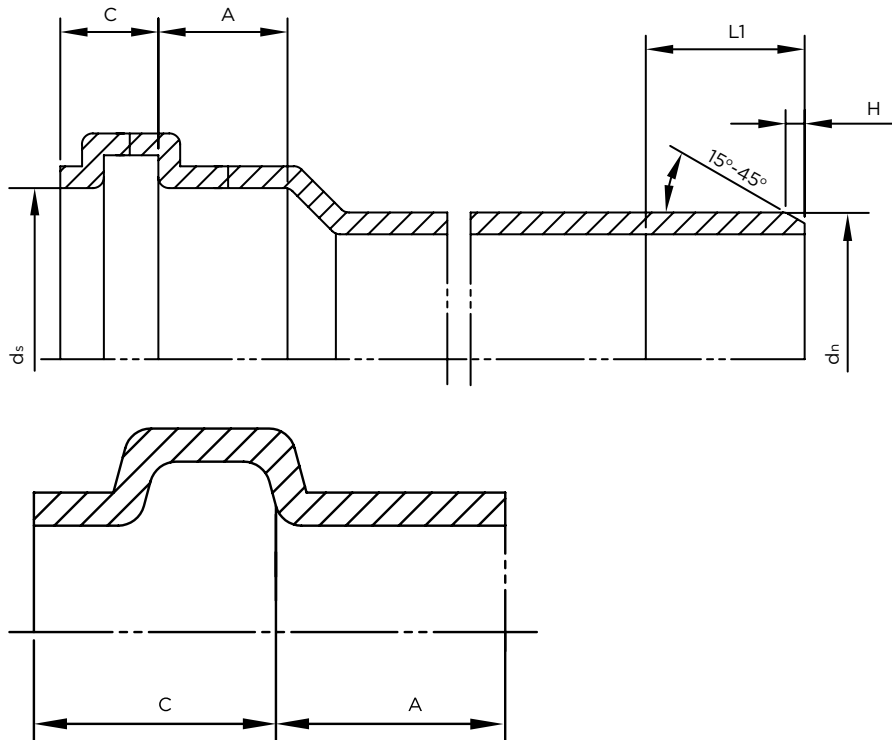

Typical Groove design for elastomeric ring seal sockets

## Diameter and lengths of elastomeric ring seal sockets and spigots ends

Nominal Outside Diameter, dn	Mean Outside Diameter, dn		Socket			Spigot	
	Min	Max	ds, min	A min	C max	L1, min	H
110	110.0	110.3	110.4	32	26	60	6
160	160.0	160.4	160.5	42	32	81	7
200	200.0	200.5	200.6	50	40	99	9
250	250.0	250.5	250.8	50	70	125	9
315	315.0	315.6	316.0	62	70	132	12

# Why only Solfit?

Ashirvad Solfit Underground drainage system pipes are manufactured as per IS 16098 (Part 1) : 2013 standard and fittings are manufactured as per EN 1401-1:2009 (SDR 41) standard in sizes ranging from 110, 160, 200, 250 and 315 mm. Ashirvad Solfit systems are joined by solvent adhesive. This system is made by new generation high tech machines and offers unrivalled performance, strength and finish.



100% leak proof joints



High flow rates - no choking



High degree of dimensional accuracy



Cost effective

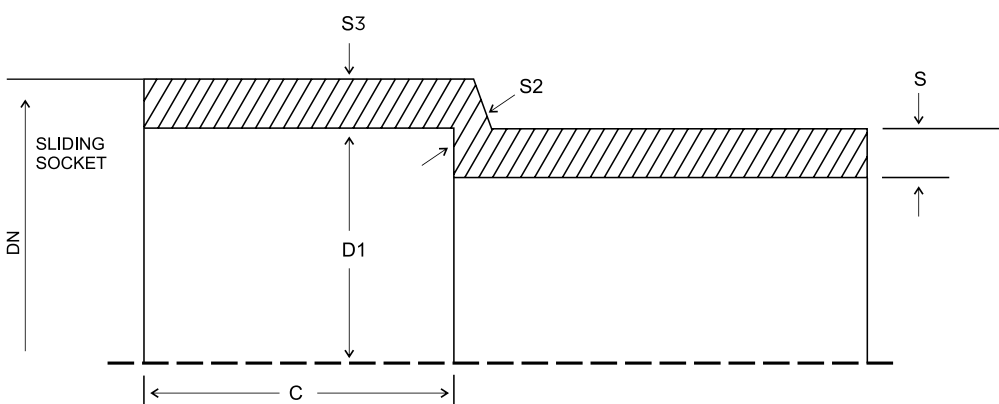

# Technical Specifications for UGD Solfit System

Ashirvad Solfit Underground drainage system pipes are manufactured as per IS 16098 (Part 1) : 2013 standard and fittings are manufactured as per EN 1401-1:2009 (SDR 41) standard in sizes ranging from 110, 160, 200, 250 and 315 mm.

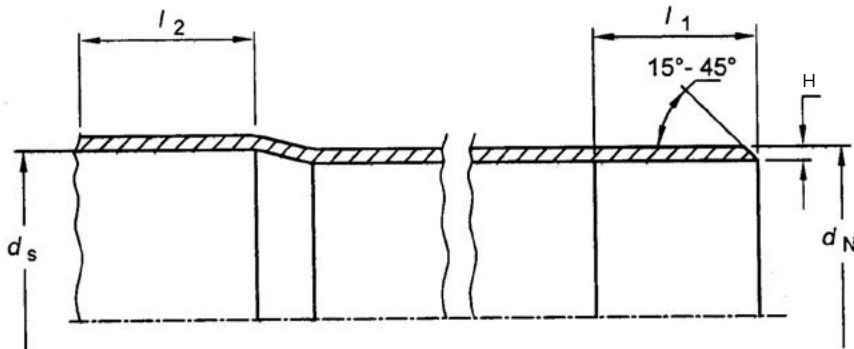

## Dimensions of sockets and spigots ends for sliding / Solfit socket joints

Nominal Outside Diameter, dn	Mean Outside Diameter, dn		Socket			Spigot	
	Min	Max	ds, min	ds, max	L2, min	L1, min	H
110	110.0	110.3	110.1	110.4	61	71	6
160	160.0	160.4	160.2	160.4	86	96	7
200	200.0	200.5	200.3	200.6	106.0	116	9
250	250.0	250.5	250.4	250.8	131.0	141	9
315	315.0	315.6	315.4	316.0	163.3	193	12

# Technical Specifications

## Dimension of pipes as per IS 16098 - Part 1 (2013)

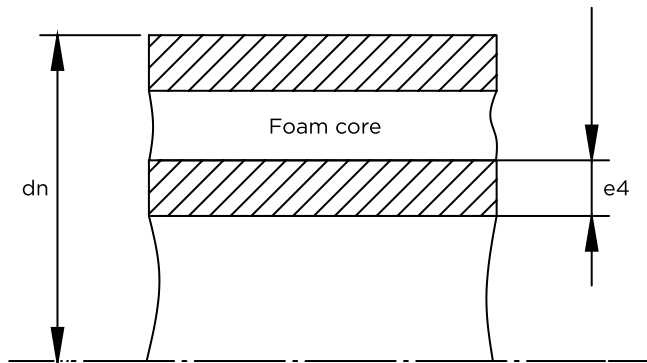

## Outside diameter and thickness of inside layer

Nominal Outside Diameter, dn	Minimum Wall Thickness of inner layer (e4, Min)
110	0.4
160	0.5
200	0.6
250	0.7
315	0.8

Dimensions in millimetres

## Effective length of pipe

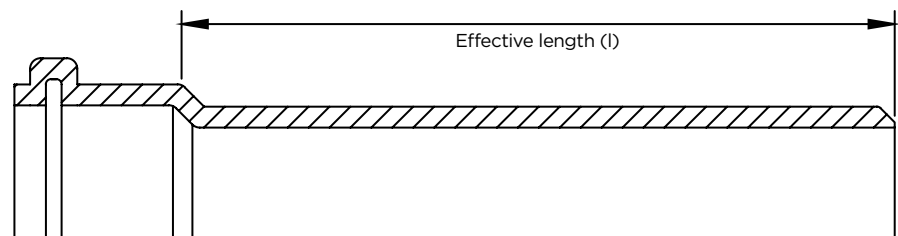

Socketed pipe

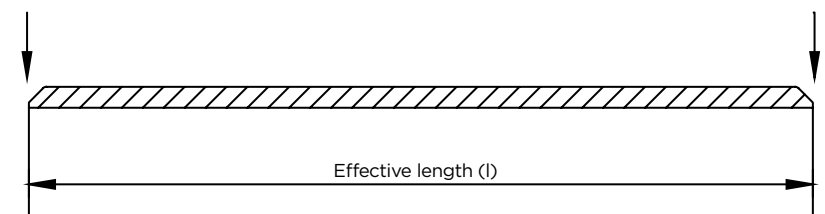

Plain ended pipe

## Pipe Availability - Pushfit & Solfit

Description	SN2	SN4	SN8
Pipe Diameter	Availability	Availability	Availability
110 mm	Not covered in IS	✓	✓
160 mm	✓	✓	✓
200 mm	✓	✓	✓
250 mm	✓	✓	✓
315 mm	✓	✓	✓

### Notes

- Pipes available with socket on single side.
- Pipes available with socket on double side.
- Pipes available without sockets (plain ended).

## Dimension of fittings as per EN 1401-1 : 2009 (SDR 41) standards

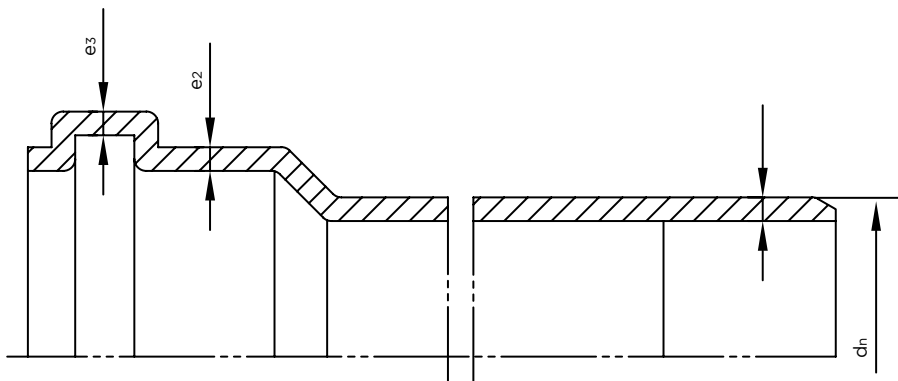

## Wall thickness of fittings

Nominal Outside Diameter $d_n$	SN 4 (SDR 41)			
	Spigot		Socket	
	e min	e max	e2 min	e3 min
110	3.2	3.8	2.9	2.4
160	4.0	4.6	3.6	3.0
200	4.9	5.6	4.4	3.7
250	6.2	7.1	5.5	4.7
315	7.7	8.7	6.9	5.8

Dimensions in millimetres

# Ring Stiffness

## Principle

The ring stiffness of a pipe indicates its ability to resist soil loads, external hydrostatic pressure, negative internal pressures and traffic loads. Nominal ring stiffness can be determined by laboratory testing and is expressed as  $\text{kN/m}^2$ . Reference IS 16098 (Part 1) : 2013. All diameters of Ashirvad foamcore pipes are manufactured with a constant minimum stiffness as either designated as SN2, SN4 and SN8 respectively in accordance with the standards.

## Test procedure

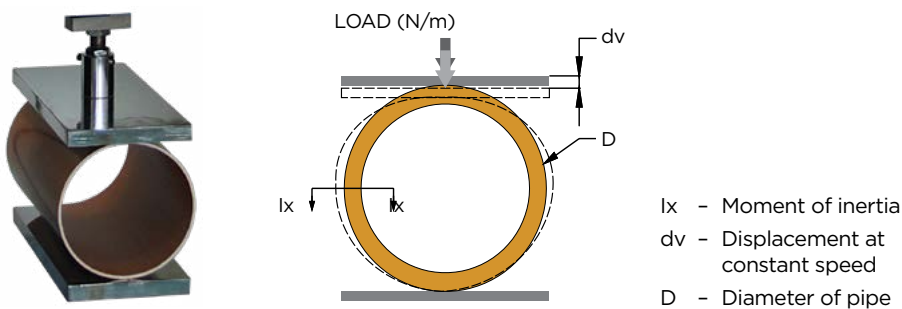

The ring stiffness is determined by measuring the force and the deflection while deflecting the pipe at a constant rate. A length of pipe supported horizontally is compressed vertically between two parallel flat plates moved at a constant speed, which is dependent upon the diameter of the pipe. A plot of force versus deflection is generated. The ring stiffness is calculated as a function of the force necessary to produce a deflection of  $0.03D$  diametrically across the pipe. The pipe is said to have passed the test if

- There is no cracking or crazing of the inside wall or liner.
- There is no wall delamination.
- The test piece has not ruptured and there are no mechanical failures.
- There is no change in shape of cross section of the pipe (buckling).

**Table 1 - Ring Stiffness of Pipes**

Stiffness Class	Ring Stiffness ( $\text{kN/m}^2$ )
SN2	$\geq 2$
SN4	$\geq 4$
SN8	$\geq 8$

# Quality Control Procedures at Ashirvad

The pipes and fittings manufactured at Ashirvad, follow a stringent quality control process before being rolled out into the market, in order to supply a defect free system to its users.

These processes follow the highest specifications of BIS (India) and EN (Europe).

## FOR PIPES



### Dimensional Check

To ensure that all pipe dimensions, particularly wall thickness and outer diameter (roundness), conform to the appropriate standards.



### Longitudinal Reversion

A pipe of specified length is placed in an air oven at a specified temperature for a specified time. A marked length of this portion of pipe is measure before and after heating. The reversion is calculated as a percentage of the change in length in relation to the initial length.



### Ring Stiffness test

The stiffness of a pipe indicates the ability of pipe to resist the external soil, hydrostatic and traffic loads together with negative internal pressure.

### Ring Flexibility test

Ring flexibility is determined by measuring the force and deflection while deflecting a ring section from the pipe diameter at a constant speed until a deflection of at least 30 percent.

## FOR FITTINGS



### Dimensions Check

To ensure that fittings have correct dimensions, particularly wall thickness, socket diameters and socket depth.



### Drop Impact Test

Fittings are dropped at 0°C from 1 meter height on the floor and observed for any cracks or failures.

## OTHER TESTS

- Color
- Vicat softening temperature
- Resistance to dichloromethane
- Creep ratio
- Resistance to combined temperature cycling and external loading
- Tightness of elastomeric sealing ring joints at 2° deflection
- Stress relief test



Inspection chamber with riser, frame and lid



# Inspection Chambers

Inspection chambers are the devices which allow access to the sewage for cleaning. Inspection chambers are used when there are too many long sewage segments, at the converging inlets, change of direction, for new connections, to disconnect public and private sewer lines and at places of sewage fall.

## Benefits of Ashirvad inspection chambers

- High flow capacity
- High hydraulic tightness
- Self cleaning
- Very low cleaning frequency
- Long lasting system
- Quick and easy installation
- Lower costs
- Easy to add additional connections

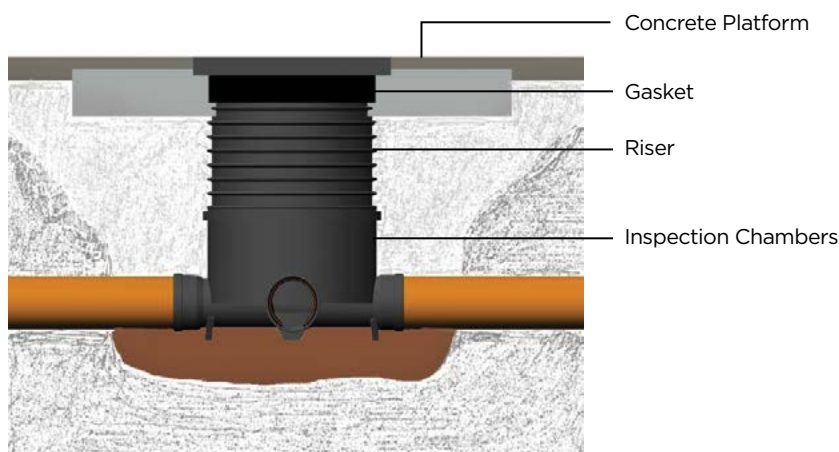

The inspection chambers can be attached to risers / raising pieces through simple dry-jointing to provide instant watertight joints. These have strengthening ribs and webbing too. Risers are used to make up the required overall height between chamber base and cover as needed.

Ashirvad provides these in diameters of 315 mm and 450 mm. The 450 mm risers have the facility to connect a 110 mm pipe at specific heights.

## Features of Ashirvad inspection chambers

- Top lid can take load of 35 KN (non-vehicular traffic and for pedestrians and light traffic only)
- Made in PP with high quality impact modifier and In-built slope from inlet to outlet
- Easy to add additional connections, inlets not used can be blocked off with dummy plugs
- Ring fit type connections for jointing
- Connection possibility with different pipe materials (ex. Clay, cast iron or PVC)
- System is provided, i.e., it comes with Riser, Lid, frame as well
- Single piece moulding for the chamber and has stability legs for quick and easy installation

# Manholes

Ashirvad manholes are made of 100% virgin UV stabilized polyethylene (PE) material and are intended for use in underground drainage and sewer systems. Innovative industrial strength design based on almost 20 years of German / European experience incorporates carefully designed ribs to provide extra strength to the product and at the same time act as an uplift prevention system against ground water.

Ashirvad manholes are rotomoulded and are made to BS EN 13598-2 : 2009 standard. Manholes have 3 way and 5 way inlets and a larger outlet. An in built slope is provided in the manhole itself.

## Benefits of Ashirvad manholes

- Fast, easy, flexible and safe installation
- Ultra durable (UV resistant PE material used)
- Corrosion resistant
- Maintenance free
- Reduced operating costs
- High quality and to EN standards
- Comes with top covers that have high load bearing capacity
- Tried and tested for over 20 years
- Environmentally friendly

## Range of manholes available

Diameter DN (mm)	Height Range (mm)	Inlet DN <sub>i</sub> (mm)	Outlet DN <sub>o</sub> (mm)	Cover DN <sub>c</sub> (mm)	Personal Entry
500	350 - 1000	110/160	110/160	500	No
600	350 - 1000	110/160	110/160	600	No
800*	1050 - 1750	110/160	110/160	600	Yes
1000**	1100 - 6000	110/160/200	110/160/200	600	Yes
		160/200/250	160/200/250	600	Yes

\*Steps are available on demand

\*\*DN1000 manhole available with additional base configurations for inlet/outlet of 315/400/500



# Speciality Fittings

## Mechanical connections

Ashirvad introduces high quality mechanical connections that can be used to join underground drainage pipes to municipal sewers. These products can be used to join to sewers made out of PE/PP/PVC - solid wall, corrugated, clay, concrete, GRP or cast iron (thickness 5 mm to 14 mm, diameter 200 mm to 400 mm).

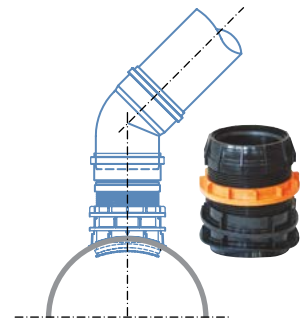

## Easy clip (160 mm and 200 mm dia)

Easy clip is used for the creation of sewer line connections using a watertight coupling device with a mechanical anchoring system. The body of the clip is made from PVC and seals are made from EPDM. Easy clip fit for purpose saddles have been successfully installed for conveying surface waters from highway bridges and to connect private underground drainage systems to the main sewers.

These products can be used to join to sewers made out of PE/PP/PVC - solid wall, corrugated, clay, concrete, GRP or cast iron (thickness 5 mm to 100 mm, diameter 300 mm to 1200 mm).

## Installation steps

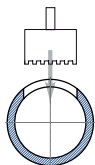

Identify the point at which to perforate the pipeline and drill the hole perpendicular to the axis of the main pipe.

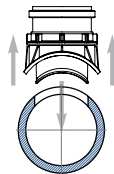

Use a suitable tool to smooth the edge of the hole as well as lubricate the seal. Also ensure a good fit of the circular interface.

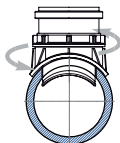

Insert the Saddles and tighten the ring nut. By turning the orange ring nut, the internal body moves upwards. The slightly conical shape of the body's base compresses the seal, thus ensuring that the hole drilled in the pipeline is properly sealed.



## Advantages of installing easy clip

- Short excavation time
- Soil re-compaction time
- No alteration of bedding
- No risk of rupture
- No digging beneath the pipeline
- No risk of interference with other utilities
- Installation without the use of sealants
- Speed of installation
- Flexible solutions
- Ease of installation

## Back Flow Preventer / Non return valves

Non return valves are simple and effective devices for reducing the risk of flood damage caused by surface water flowback through the underground drainage system. Injection moulded non return valves made of uPVC designed for connections to piping systems conform to European EN 1329 and EN 1401 standards.



The main causes of back flow are

- Overall under-sizing of the public sewage.
- High peak of flow (example in case of intense rainfalls).
- Growing urbanization areas means greater sewage volume to be evacuated.
- Malfunctioning or blockages downstream in the network.

## Main functioning components and operation

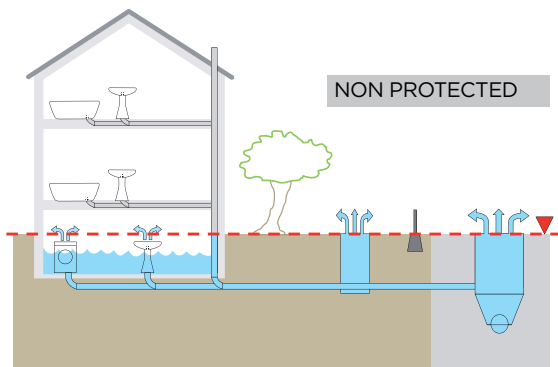

Back flow event: without non return valve

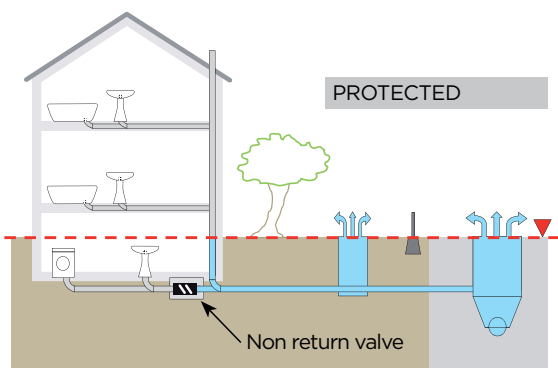

Back flow event: with non return valve

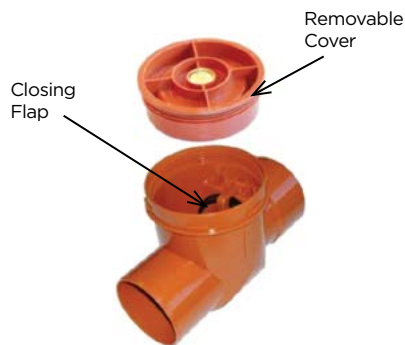

## Installation

Installation of NRV is within an access point between the facility to be protected and main sewer. Any flowback will automatically shut the valve.

This product can be obtained in sizes from 110 mm to 315 mm from Ashirvad.

## Swivel

Swivel joint for the compensation of settling side when used with inspection chambers. Special kneecap compensation whose seat is obtained by the coupling of 2 hemispheres. The product comes from Redi mounted, pre-lubricated and ready to use. The end can absorb inclinations of the pipe up to  $\pm 10^\circ$ .

**Installation:** Suitable for systems with O-ring seal. Always chamfer cut pipe and lubricate all plain ended spigots for perfect push-fit.



## Installation Procedure

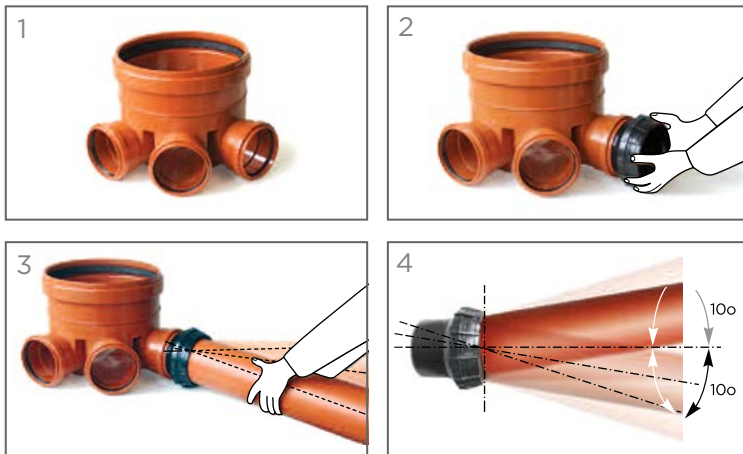

## DN 160 mm

- Pre lubricated and ready to install
- Rotation up to  $10^\circ$  to ease house connections and balance ground settlement

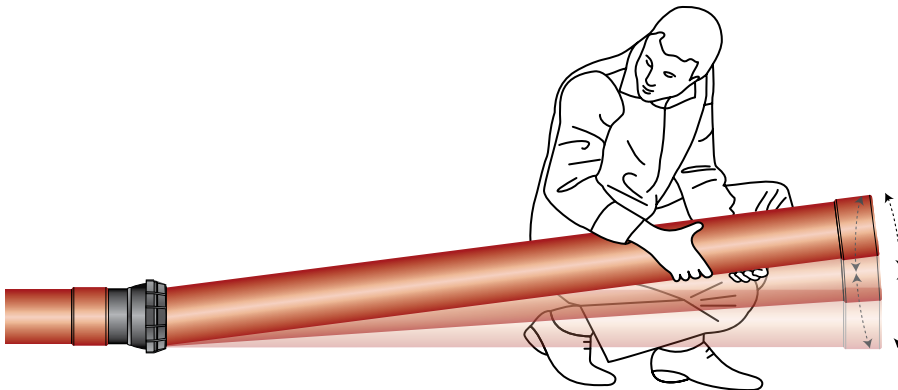

# SMART WATER MANAGEMENT

With technical tie ups from across the globe, Ashirvad strives to bring the latest technology and products into the Indian plumbing market, with more and more satisfied customers each day.



# Applications of Underground Drainage System

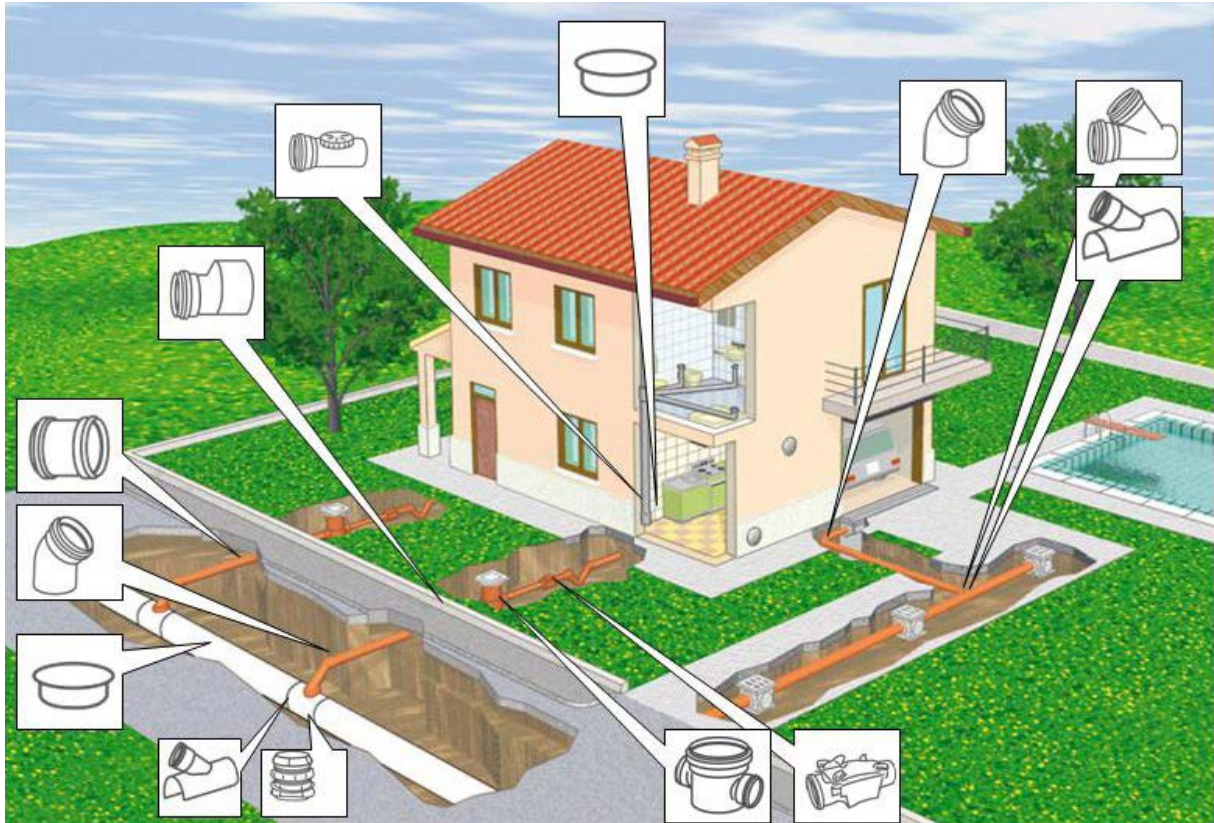

Ashirvad underground drainage and sewerage system has been designed with a view to modern man's inclination towards health, hygiene and his aversion to filth and pollutants. Due to unpleasant nature of human waste, a drainage system should be "out of sight and out of mind". Most of the drainage systems are actually hidden from sight.

Ashirvad underground system can also be used for rainwater collection and disposal, including rainwater harvesting. In short, the system provides complete solution for underground drainage and sewerage applications.

## Good practice guide for underground drainage systems

- Pipes to be laid at such a gradient as to ensure a self-cleansing velocity.
- Pipes to be of sufficient size to cope effectively with the maximum load to be carried.
- Efficient means of ventilation to be provided and maintained.
- Adequate means of access to be provided.
- Length of branch drains to be kept to a minimum and all junctions to be made in the direction of flow.
- Pipes to pipe and pipe to fitting to be watertight joints.
- Every part of the drainage system to be adequately supported.
- So far as circumstances will permit, drains should not pass under buildings.
- Drains to be laid as far as possible in straight lines between points where access is provided.
- Drains not to be laid in close proximity to trees owing to the possibility of damage being caused by roots.

# Handling and Storage

## Proper Handling



Please check and inspect the pipes on receipt. The pipes should be checked for any forms of transport damage due to shift in loads or improper handling/treatment. Visually examine the ends of pipes for any cracks or damage.



The pipes should be handled with care. The tendency to throw or drop the pipes to the floor should be avoided. Do not drag or push the pipes from a truck bed. Contact of pipes with from any sharp object should be totally avoided.

## Storage of Pipes

The pipes should preferably be stored indoors. When this is not possible, please ensure to:



- Protect the pipes from sun light, to reduce the effect of UV rays.
- Store on level ground and dry surface.

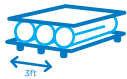

- If pipes of same diameter but different classes are being stacked together, place the thicker pipes below. i.e., Stack below SN2, SN4 and SN8. If placing pipes on racks, ensure the spacing between the supports does not exceed 3 feet.

## Correct Transportation procedure



Where possible use a truck for deliveries. Lay pipe flat on the tray.



Alternate socket and pipe ends when loading pipe.



Keep pipe strapped down so it doesn't roll around and remains supported.





# Installation Guide for Pushfit

**Easy and 100% leakproof installation.**

## Step 1: Cutting

Measure and cut pipe to size. Ensure to cut the pipes straight and square to provide optimal bonding area for the solvent cement. Inspect pipe ends thoroughly before making the cut, if any cracks or split in the ring is noticed cut off a minimum of 25 mm beyond the visible crack before proceeding.

## Step 2: Chamfering and Deburring

Burrs in and on pipe end can obstruct flow/proper contact between the pipe and socket of the fitting during assembly and should be removed from both in and outside of the pipe. A 15 mm dia half round file/a pen knife or a Deburring tool are suitable for this purpose.

A slight bevel on the end of the pipe will ease entry of the pipe into the socket of the fitting socket.

## Step 3: Fitting Preparation

Use a clean dry cloth to wipe the dirt, moisture from the fitting and pipe end.

## Step 4: Check for Brown Seal™

Check the socket end for **Brown Seal™**. Ensure that the brown part of the seal is towards the outside of socket.

## Step 5: Lubricant

Apply the lubricant on the chamfered end of the pipe.

## Step 6: Assembly

Immediately insert the pipe into the fitting socket. Rotate the pipe slightly while inserting. Withdraw pipe until the mark is 12 mm away from socket. This means a 12 mm gap exists between the end of the pipe and the socket register. This gap will allow the pipe to expand without distorting the pipe-work jointing.

**ASHIRVAD underground pipes and fittings are joined with the help of Ashirvad Lubricant. For faster plumbing and leak proof joints we strongly recommend the use of Ashirvad lubricants only.**

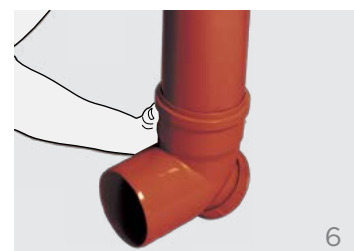
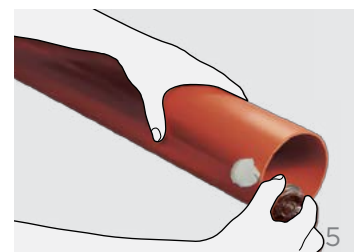
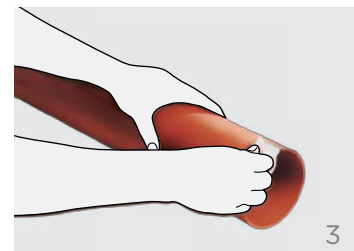
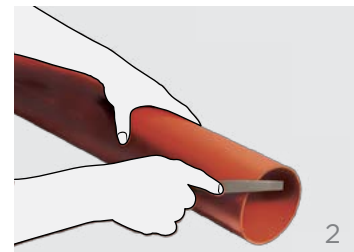
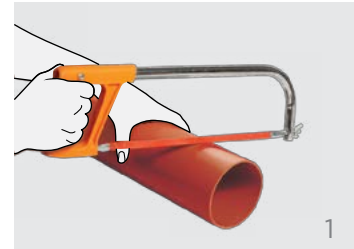

# Installation Guide for Solfit

**Easy and 100% leakproof installation.**

## Step 1: Cutting

Measure the pipe length accurately and make a visible marking using a felt tip pen. Ensure that the pipe and fittings are size compatible. You can easily cut with a plywood cutting saw/ ratchet cutter or a wheel cutter. Cutting the pipe as squarely as possible (at 90°) provides optimal bonding area within a joint. Inspect pipe ends thoroughly prior to making a joint. If a crack or splintering is noticed cut-off a minimum of 25 mm beyond the visible crack before proceeding.

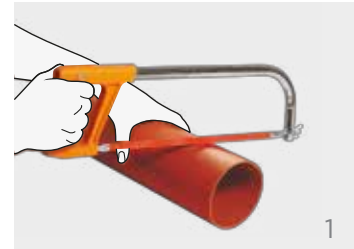

## Step 2: Deburring/Beveling

Burrs in and on pipe end can obstruct flow/proper contact between the pipe and socket of the fitting during assembly and should be removed from both in and outside of the pipe. A 15 mm dia half round file/a pen knife or a deburring tool are suitable for this purpose. A slight bevel on the end of the pipe will ease entry of the pipe into the socket of the fitting socket.

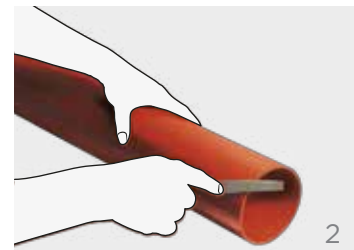

## Step 3: Fitting Preparation

Using a clean dry rag, wipe the dirt and moisture from the fitting sockets and pipe end. Dry fit the pipe to ensure total entry into the bottom of the fittings socket and make a visible marking using a felt tip pen.



## Step 4: Solvent Adhesive Application

Apply an even coat of solvent adhesive on the pipe and the socket end of the fitting. Do not use thickened or lumpy solvent adhesive. It should have a flow consistency like that of syrup or paint.

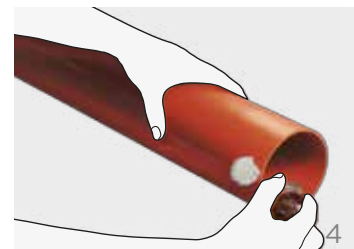

## Step 5: Assembly

Immediately insert the pipe into the fitting socket, rotate the pipe ¼ to ½ turn while inserting. This motion ensures an even distribution of adhesive within the joint. Hold the assembly for 10 seconds to allow the joint to setup.

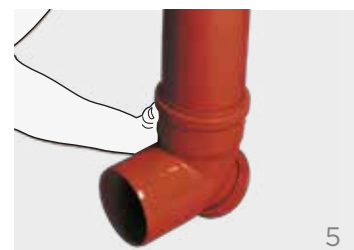

**ASHIRVAD Solfit Pipes and Fittings are joined with the help of Ashirvad solvent adhesive, which is a single step fast setting solvent adhesive. The bonding takes place due to chemical fusion of the mating surfaces.**

# Trench Excavation

Trench excavation are carried out principally to allow installation or repair of public utilities, drains and sewers to serve populated areas. The density of the backfill material, the width of the trench at the crown of the pipe,  $b$ , and the nominal outside diameter of the pipe,  $D$ , and the height of backfill ( $h_t$ ) all influence the loads imposed on the pipe.

## Types of Trench

### Narrow Trench

The pipe is laid in a relatively narrow trench with backfill properly compacted, the weight of fill is jointly supported by both the pipe and the frictional forces along the trench walls.

The narrow trench condition is used where excavation commences from the natural ground surface without any fills above the surface.

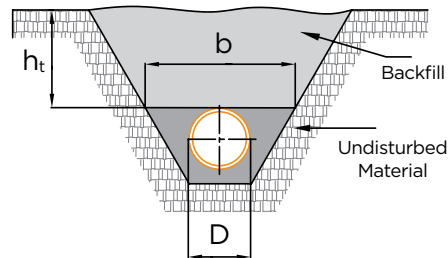

Narrow Trench

### Wide Trench

A wide trench gives rise to loads greater than those which occur in narrow trench owing to the greater mass of backfill bearing on the pipe, although friction between the undisturbed trench side and the backfill reduces the load to some extent.

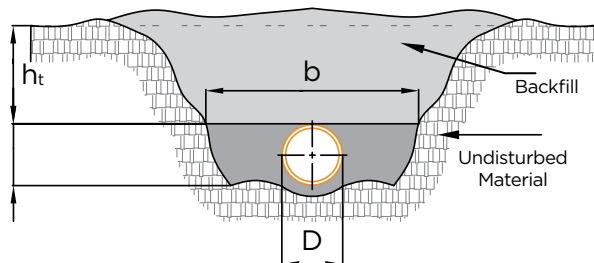

Wide Trench

## Recommended steps for installation of Ashirvad Underground Drainage pipes

1. Trench excavation
2. Compaction
3. Sand bedding and pipe laying
4. Sand filling upto crown of the pipes
5. Side filling
6. Back filling
7. Final compaction



### Important Note

When a trench excavation is being planned for, a thorough search should be made for information about any existing utilities adjacent to or crossing the line of the planned trench, including their sizes, locations and alignments. Most of the underground utilities are live systems, such as electricity, water, sewer and gas, and can be dangerous to workers when damaged or fractured.

Also consideration to water bodies or surface water is to be given to ensure no buoyancy effects on the underground drainage system.

# Pushfit Underground Fittings - Technical Details

## PLAIN BEND 45°

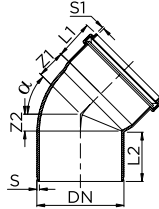

Size (in)	$\alpha$	DN	S	Z1	Z2	L1	L2
4	45°	110	3.3	23.2	37	64	54
6	45°	160	4.1	33.1	50.2	87	70.9
8	45°	200	5.0	41.4	64.5	110	85.0

## COUPLER

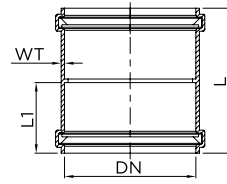

Size (in)	DN	S	L1	L2
4	110	3.0	61.5	127
6	160	3.7	79.1	163.6
8	200	4.5	95.8	197
10	250	5.6	122.3	251.5
12	315	7.0	142.5	294.0

## PLAIN BEND 87.5°

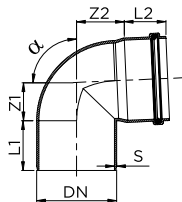

Size (in)	$\alpha$	DN	S	Z1	Z2	L1	L2
4	87.5°	110	3.3	52.7	66.7	64	54
6	87.5°	160	4.1	76.6	93.7	87	70.9
8	87.5°	200	5.0	95.7	118.9	110	85.0

## REPAIR COUPLER

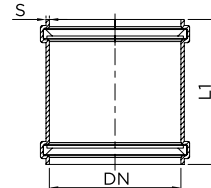

Size (in)	DN	S	L1
4	110	3.0	127
6	160	3.7	163.6
8	200	4.5	197
10	250	5.6	251.5
12	315	7.0	294.0

## REDUCING COUPLER

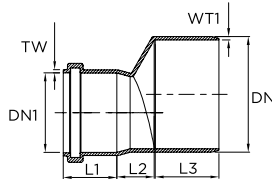

Size (in)	DN	DN1	S	L1	L2	Z
6 x 4	160	110	4.1	54	82	51
8 x 6	200	160	5.0	70.9	100	43.1
10 x 8	250	200	6.3	85.0	133.0	52
10 x 6	250	160	6.3	7.09	133.0	45.1
12 x 8	315	200	7.8	85.0	150.0	75.9
12 x 10	315	250	7.8	111.0	150.0	52.8

## LONG SWEEP BEND 87.5° PLAIN

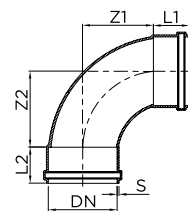

Size (in)	$\alpha$	DN	S	Z1	Z2	L1	L2
4	87.5°	110	3.3	102.4	102.4	60	60
6	87.5°	160	4.1	145.3	145.3	81	81
8	87.5°	200	5.0	184	184	100	100

The following notation (symbols) shall apply in this reference manual.

DN - Nominal Diameter  
 DN1 - Manhole ID  
 DN2/DN3/DN4 - Socket ID  
 L1 - Total length

L2 - Length from manhole centre to socket  
 L3 - Total height  
 L4 - Bottom to centre of socket

SINGLE TEE PLAIN

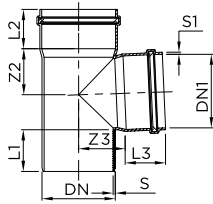

Size (in)	DN	DN1	S	Z1	Z2	L1	L2
4	110	111.5	3.3	52.7	69.3	64	54
6	160	161.5	4.1	76.6	98.7	87	70.9
8	200	201.8	5.0	96	125.3	110	85.0

END CAP

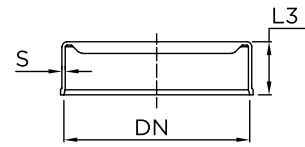

Size (in)	DN	S	L3
8	200	3.1	38.7
10	250	3.6	40.5
12	315	4.1	52.5

REDUCING SINGLE TEE

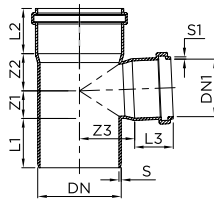

Size (in)	DN	DN1	S	S1	Z1	Z2	Z3	L1	L2	L3
6 x 4	160	111.5	5.0	3.0	51.4	76.7	54	87	70.9	54

BOTTLE GULLY TRAP WITH JALI - SINGLE SIDE

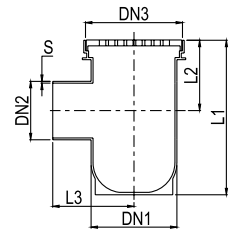

Size (mm)	DN1	DN2	DN3	S	L1	L2	L3
160 x 110	161	109.5	182	3.25	290	132	152.5

LONG SWEEP TEE PLAIN

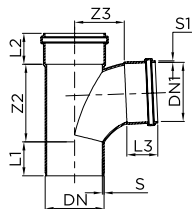

Size (in)	DN	S	S1	Z2	Z3	L1	L2	L3
4	110	3.3	3.0	167	100	64	54	60
6	160	4.1	3.7	239.1	141.9	87	70.9	81
8	200	5.0	4.5	302.3	180	110	85.0	100

BOTTLE GULLY TRAP WITH JALI - DOUBLE SIDE

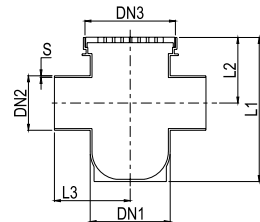

Size (mm)	DN1	DN2	DN3	S	L1	L2	L3
160 x 110	161	109.5	182	3.2	290	132	152.5

DUMMY PLUG

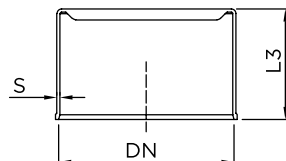

Size (in)	DN	S	L
4	110	3.0	69.5
6	160	3.0	88.5

SINGLE WYE 45° PLAIN

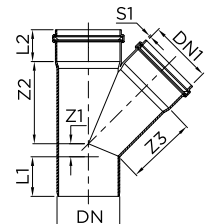

Size (in)	DN	DN1	S	S1	Z1	Z2	Z3	L1	L2	L3
4	110	111.5	3.3	3.0	22.8	140	140	64	54	54
6	160	161.5	4.1	3.7	33.2	202.6	202.6	87	70.9	70.9
8	200	201.8	5.0	4.5	42	254.8	254.8	110	85.0	85.0

#### CLEANING PIPE

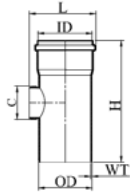

Size (in)	DN	ID	OD	WT	C	H	L
4	110	111.5	110	3.3	90.40	261.50	140.30
6	160	161.5	160	4.1	89.20	362.50	183.50
8	200	201.8	200	5.0	161.60	412.77	301.30

#### BACKFLOW PREVENTER

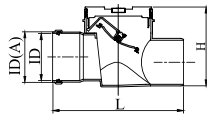

Size (in)	Size (mm)	Socket ID	Groove ID (A)	WT	H	L
4	110	111.30	121.3	3.2	170	280
6	160	161.5	175.0	4.0	257	396
8	200	205.0	225.0	6.0	257	442
10	250	264.0	275.0	7.0	330	520
12	315	325.0	365.0	10.0	395	630

#### RUBBER WASHER

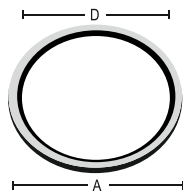

Size (in)	Size (mm)	ID	OD	WT
4	110	111.3	121.5	8.1
6	160	161.5	174.14	10.7
8	200	193.3	215.5	11.9
10	250	239.6	272.8	19.0
12	315	303	341.0	20.20

#### RUBBER LUBRICANTS



Weight in Grams

Container Type

100	Can
250	Can
500	Can

# Solfit Underground Fittings - Technical Details

## PLAIN BEND

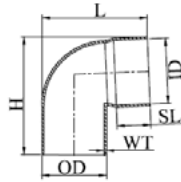

Size (in)	Size (mm)	ID	OD	SL	WT	H	L
4	110	111.30	110.40	48	3.2	178	170
6	160	161.50	160.50	58	4.0	248.2	230

Size (in)    Size (mm)    ID    OD    SL    WT    H    L

4	110	111.30	110.40	48	3.2	232	175
6	160	161.50	160.50	58	4.0	319	250

## COUPLER

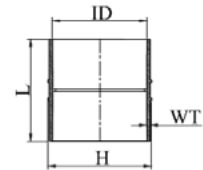

Size (in)	Size (mm)	ID	WT	H	L
4	110	111.30	3.2	120	102
6	160	161.50	4.0	170	125
8	200	200.60	4.6	210	219
10	250	250.8	5.7	262	271
12	315	316.0	7.2	331	338

## BEND 45°

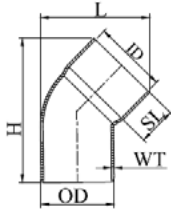

Size (in)	Size (mm)	ID	OD	SL	WT	H	L
4	110	111.30	110.40	48	3.2	186	156
6	160	161.50	160.50	58	4.0	253	199

## EQUAL ELBOW

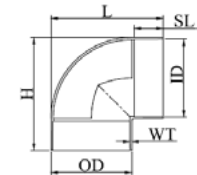

Size (in)	Size (mm)	ID	OD	SL	WT	H	L
4	110	111.30	110.40	48	3.2	276	235
6	160	161.50	160.50	58	4.0	380	330

Size (in)	Size (mm)	ID	OD	SL	WT	H	L
8	200	200.6	209.8	106	4.6	320	320

## EQUAL TEE

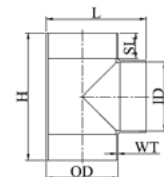

## SINGLE TEE

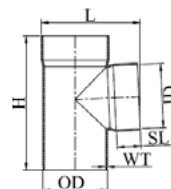

Size (in)	Size (mm)	ID	OD	SL	WT	H	L
8	200	200.6	209.8	106	4.6	430	320



### REDUCER OFFSET

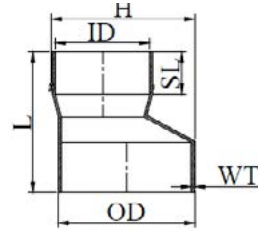

Size (in)	Size (mm)	ID	OD	SL 1	SL 2	WT	H	L
6 X 4	160 X 110	111.30	160.5	48	58	4	118.23	155.5

### REDUCING TEE

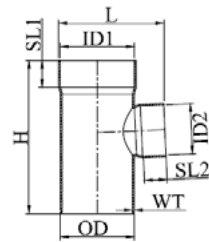

Size (in)	Size (mm)	ID 1	ID 2	OD	SL 1	SL 2	WT	H	L
6 X 4	160 X 110	161.50	111.30	160.30	58	48	4	319	227

### REDUCER COUPLER

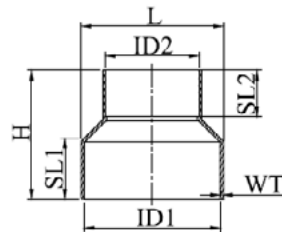

Size (in)	Size (mm)	ID 1	ID 2	SL 1	SL 2	WT	H	L
8 X 6	200 X 160	200.6	161.5	106	58	4.6	222	210
10 X 8	250 X 200	250.8	200.6	131	106	5.7	272	265
12 X 10	315 X 250	316.0	250.8	163.5	131	7.2	314	316

### Solvent Adhesive



#### Weight in Litres

#### Container Type

100 ml	Can
250 ml	Can
500 ml	Can
1000 ml	Can

# Inspection Chambers - Technical Details

## 315 x 110 mm 6-LINE ACCESS JUNCTION BASE

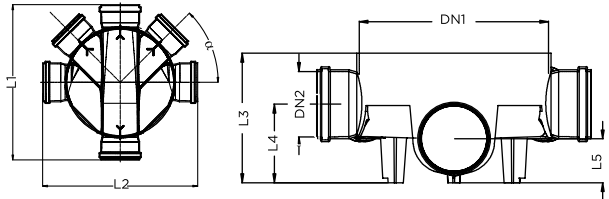

Size (mm)	$\alpha$	DN	DN1	DN2	L1	L2	L3	L4	L5
315 x 110	45°	315	322	111.5	466.6	466.6	220	133.5	74.5

## 315 x 110 mm 4-LINE ACCESS JUNCTION BASE

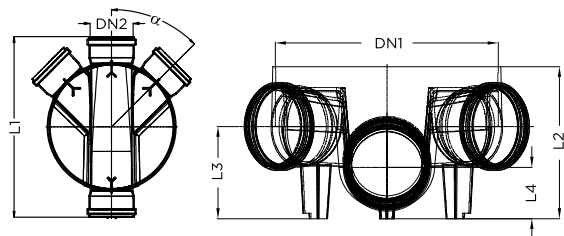

Size (mm)	$\alpha$	DN	DN1	DN2	L1	L2	L3	L4
315 x 110	45°	315	322	111.5	466.6	220	133.5	74.5

## 315 x 110 mm LEFT/RIGHT HAND 90° JUNCTION

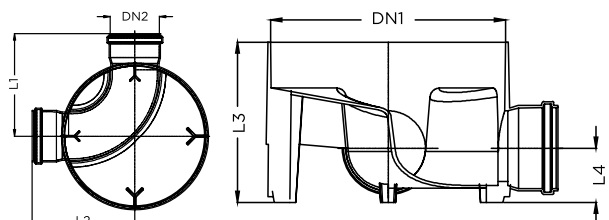

Size (mm)	DN	DN1	DN2	L1	L2	L3	L4
315 x 110	315	322	111.5	233.3	233.3	220	74.5

315 x 110 mm TWO 90° INLET JUNCTION

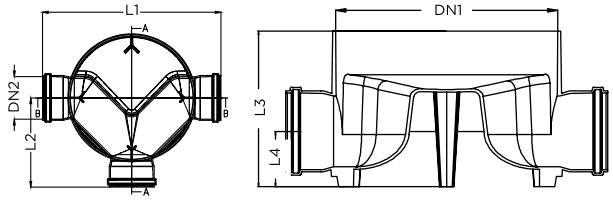

Size (mm)	DN	DN1	DN2	L1	L2	L3	L4
315 x 110	315	322	111.5	466.6	233.3	220	74.5

315 x 110 mm RIGHT HAND 90° JUNCTION

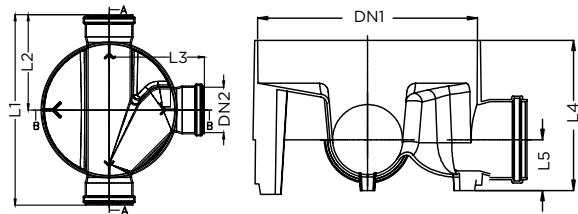

Size (mm)	DN	DN1	DN2	L1	L2	L3	L4	L5
315 x 110	315	322	111.5	466.6	233.3	220	220	74.5

315 x 110 mm LEFT HAND 90° JUNCTION

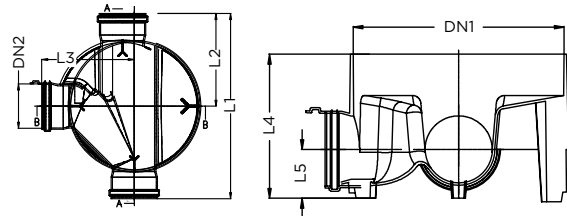

Size (mm)	DN	DN1	DN2	L1	L2	L3	L4	L5
315 x 110	315	322	111.5	466.6	233.3	220	220	74.5

315 x 110 mm STRAIGHT THROUGH

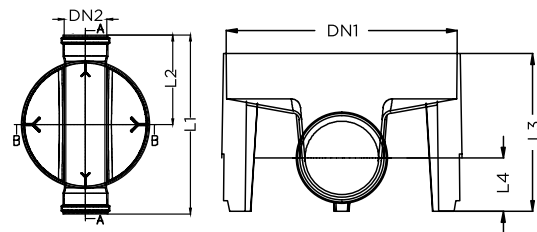

Size (mm)	DN	DN1	DN2	L1	L2	L3	L4
315 x 110 mm	315	322	111.5	466.6	233.3	220	74.5

## 450 MM INSPECTION CHAMBER BASE

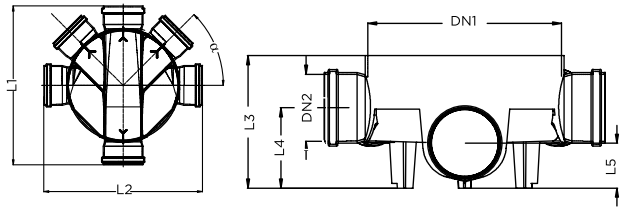

Size (mm)	DN	DN1	DN2	DN3	DN4	L1	L2	L3	L4	L5
450 x 200 x 160 x 110	45	471.9	161.5	201.8	111.5	695	658.8	375	218	133
450 x 160 x 110	45	471.7	161.5	161.5	111.5	656.6	655	325	198	118

## RISER

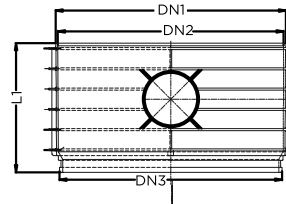

Size (mm)	DN	DN1	DN2	DN3	L1
315	315	331.8	323.4	315.0	159.7
450	450	482	472.5	466	270.2

## FRAME

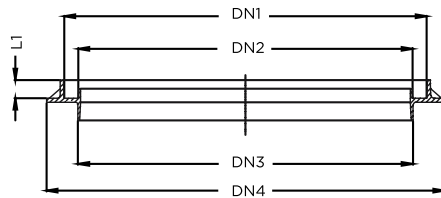

Size (mm)	DN	DN1	DN2	DN3	DN4	L1
315	315	358.1	293.5	295.1	405.1	25
450	450	492	453.4	454	539.8	25

## LID

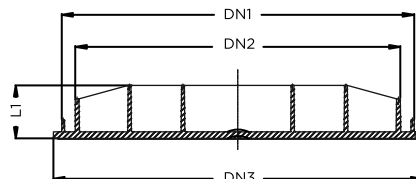

Size (mm)	DN	DN1	DN2	DN3	L1
315	315	332.1	280.1	355.6	51.7
450	450	466	430	488	70.4

# Inspection Chambers and Manholes - Technical Details

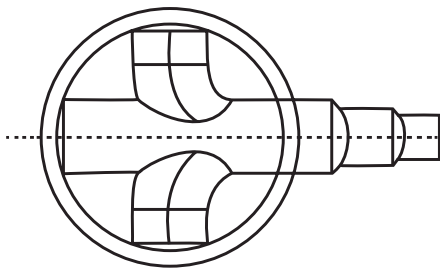

3 way

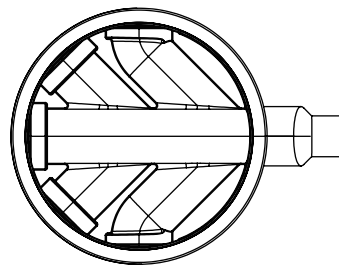

5 way

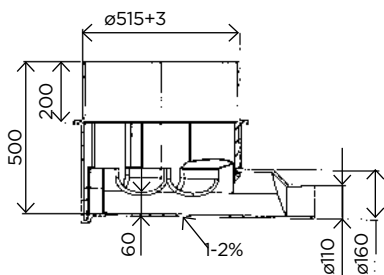

500 mm dia inspection chamber

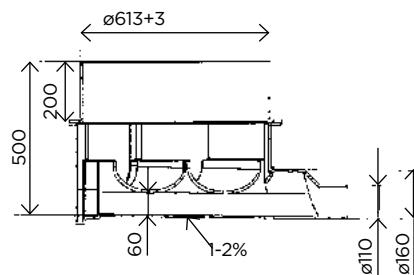

600 mm dia inspection chamber

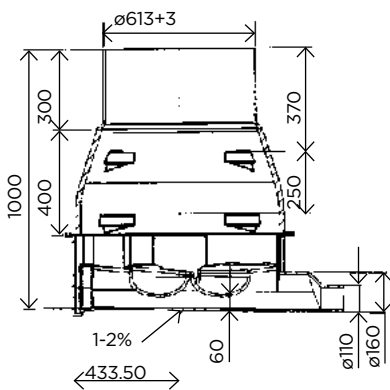

800 mm dia manhole

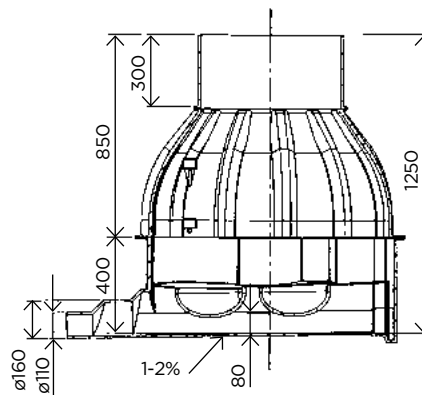

1000 mm dia manhole

## Dimensions

Diameter id (mm)	3 way / 5 way	Inlet pipe dia (mm)	Outlet pipe dia (mm)	Height range* (mm)	Manual entry / Steps	Standard
500	5 way only	Up to 160 mm	Up to 160 mm	350 - 1000	No	EN 13598-1
600	3 way	Up to 250 mm	Up to 250 mm	350 - 1000	No	EN 13598-1
	5 way	Up to 160 mm	Up to 160 mm	350 - 1000	No	EN 13598-1
800	3 way	Up to 250 mm	Up to 250 mm	1000 - 1750	Yes	EN 13598-2
	5 way	Up to 160 mm	Up to 160 mm	1000 - 1750	Yes	EN 13598-2
1000	3 way	Up to 315 mm	Up to 315 mm	1100 - 6000	Yes	EN 13598-2
	5 way	Up to 200 mm	Up to 200 mm	1100 - 6000	Yes	EN 13598-2

\*Riser height is at 250 mm and 450 mm.



# Ashirvad Underground Drainage System Limited Warranty

## **The limited warranty will not apply if**

1. Ashirvad products are used in combination with any other brand / make of pipes, fittings and accessories.
2. The product is used for applications other than underground drainage.
3. The product fails due to defects or deficiencies in design, engineering or installation.
4. Ashirvad Lubricant is not used for Ashirvad Solfit systems.
5. The Installation manual for the use of the product is not followed.
6. The pipe is not warranted against any mechanical damage by nails, drilling, chiselling, dropping pipes on stones or rocks with sharp edges, etc.

## **Ashirvad underground drainage system limited warranty**

Ashirvad Pipes Pvt. Ltd., Bengaluru warrants to the original owner that the product will be free from manufacturing defects and conform to current applicable Indian and European standards under normal use. Buyers' remedy for breach of this warranty is limited to replacement of, or credit for, the defective product. This warranty excludes any expense for removal or reinstallation of any defective product and any other incidental, consequential or punitive damages.

**TM & PATENT:** Any unauthorized use, copying, manufacturing etc. of the similar product or technology of the invention protected will attract legal actions including, imprisonment or fine under relevant IP laws • Printed in 2020 • All rights reserved. No part of this publication may be copied, modified, reproduced in any material from (including photocopying or storing it in any medium by electronic means and whether or not transiently or incidentally to some other use of this publication) without the written permission of the copyright owner. Applications for the copyright owner's written permission to reproduce any part of this publication should be addressed to the copyright owner. **Warning:** The doing of an unauthorized act in relation to a copyright work may result in both a civil claim for damages and criminal prosecution. **Disclaimer:** Due care and diligence has been taken while editing and printing the book. Neither the author nor the publishers of the book hold any responsibility for any mistake that may have inadvertently crept in. Publishers shall not be liable for any direct, consequential, or incidental damages arising out of the use of the book. In case of binding mistake, misprints, or for missing pages etc. • Printed and bound in India. Moral Rights of the Author are asserted • The copyright owner reserves all rights and liberty to modify, change or alter the design drawings of the products as and when it deems appropriate and necessary without any prior notice to the users.

All rights reserved copyright © 2020 Ashirvad Pipes Private Limited

**Ashirvad Pipes Pvt. Ltd.**, 4-B, Attibele Industrial Area, Hosur Road, Bengaluru - 562 107, Karnataka, INDIA.

**T:** +91 80 2806 1000 / 2806 1700 **F:** +91 80 2806 1080

**For any Service / Customer complaint / Queries:**

**Toll Free:** 1800 572 8900 **M:** +91 9902 333 333 **E:** [customercare@ashirvad.com](mailto:customercare@ashirvad.com)

**SMART WATER MANAGEMENT** PLUMBING . SANITARY . AGRICULTURE



by **alixis**



[www.ashirvad.com](http://www.ashirvad.com)