

ashirvad

by aliaxis

SWR DRAINAGE SYSTEM

Faster Installation Leak-Proof Joints

TECHNICAL MANUAL



Faster installation leak-proof joints

The Yellow Seal™ holds itself permanently in the 'groove' and does not fall out. The rubber ring ensures leak free joints and helps compensate for the thermal expansion and contraction of plastic.



ashirvad

110MM O.D. S.W.R. uPVC PIPES (TYPE A)



IS 13692
CML: 4497178

ashirvad

75MM O.D. S.W.R. uPVC PIPES (TYPE A)



IS 13692
CML: 4497178





Index

01

About Ashirvad	09
Certifications	10
About Aliaxis	11
10 Assurances	16

02

About uPVC	19
Chemical resistance of uPVC	20

03

Why only Ashirvad SWR?	27
About Yellow Seal™	28
Why only Pushfit?	32
Why only Solfit?	34

04

Quality Control Procedures at Ashirvad	37
Handling and Storage of Pipes	39
Installation Guide Pushfit	40
Installation Guide Solfit	41
Installation Guides and Tips	42
Testing of System	43

05

Product Dimensions - Pushfit Fittings	44
Product Dimensions - Solfit Fittings	48
Product Dimensions - Common Fittings	53
Other Products in SWR Portfolio	57
Do's and Dont's	58

Water - In all its forms,
a precious gift to life around,
ever flowing, never stopping,
always forward bound.

From the sky, from the rivers,
from the lakes around
Bringing joy, bringing cheer
abundant & profound
Water, water everywhere,
happiness abound

“Khushiyon ke rang - paani ke sang”

be **water happy**™



ashirvad

160MM O.D. S.W.R. SILENT PLUS PIPES 10dB/2LPS TESTED TO EN 14366.

ashirvad

110MM O.D. S.W.R. SILENT PIPES 13dB/2LPS TESTED TO EN 14366.

+ **ashirvad** SDR 11 **FLOWGUARD™ PLUS**

+ **ashirvad** SDR 11 **FLOWGUARD™ PLUS**

ashirvad

AQUALIFE™ (DN 20mm) 3/4" uPVC ASTM - D - 1785 SCHD 40 LEAD FREE

ashirvad

HEAVY CLASS

ashirvad

STANDARD CLASS

About Ashirvad

Ashirvad an Aliaxis group company, setup its Bengaluru unit in 1998 and is a wholly owned company of Aliaxis group. Aliaxis group is a global leading manufacturer and distributor of plastic fluid handling systems used in residential, commercial and industrial buildings. Aliaxis, headquartered in Brussels and is present over 45 countries with more than 100 manufacturing and commercial entities, employs over 16,000 people and generates more than 3 billion Euro (₹ 21, 600 crores approx) in annual sales.

Ashirvad has always been relentless in its commitment to quality and services. Ashirvad pipes is a leading manufacturer and supplier of CPVC, uPVC, SWR plumbing systems and also the pioneer in designing and manufacturing of uPVC column pipes, which are used in the erection of submersible borehole pumps. Today Ashirvad Pipes is the world's largest manufacturer of uPVC column pipes and successfully exporting to 40+ countries. The CPVC Hot and Cold plumbing system is manufactured in collaboration with Lubrizol, USA.

Ashirvad is an ISO 9001:2015, ISO 14001:2015 and ISO 45001:2018 certified company with a constant endeavour towards achieving the highest level of customer satisfaction.

Ashirvad, with a determination to be a one-stop-shop for Plumbing, Agriculture, Sanitary, High-rise and Fire Safety solutions, has recently expanded its product range and successfully introduced Agri Pipe, Casing Pipe, BlazeMaster® Pipes & Fittings by Ashirvad.

Capabilities:

- Manufacturing capacity of more than 2,00,000 MT per annum
- Total factory area of 50 acres
- 500+ Strong Sales & marketing staff across India
- Strong team of 205 at corporate office
- Over 4,500 manufacturing workforce
- 11 warehouses, 1,100 distributors, 53,000 dealers across India
- Exporting Column Pipes to more than 40 countries
- 2 factories in Bengaluru and another one in Bhiwadi (Rajasthan) near Delhi



In 2007, Ashirvad won the National Award for "OUTSTANDING ENTREPRENEURSHIP IN MEDIUM ENTERPRISES"

The award was presented by the Prime Minister of India.



WCRC Leaders Summit - 2014

Ashirvad Pipes

"One Of The 100 Fastest Growing Marketing Brands In Asia"

(Evaluated and selected by KPMG)
The Global Audit Firm



Construction Industry Database (CIDC) - 2016 Has been enlisted as an **Approved Vendor** for providing the following Services / Products
Manufacturing of
CPVC & uPVC Pipes & Fittings

Certifications

intertek
Test Quality. Assured.

CERTIFICATE OF REGISTRATION

This is to certify that the management system of
Ashirvad Pipes Pvt. Ltd.

Site 1: Plot No. 4-B, 26 & 26-B Attibele Industrial Area, Hosur Road, Bangalore - 562107, Karnataka, India
Site 2: Plot No. 27-F, 28-F, 29-F & 30, Bommasandra-Igani Link Road, Industrial Area, Igani Hobli, Anekal Taluk, Bangalore - 560055, Karnataka, India
Site 3: Plot No. SP1-177 & 178, Kalyani Industrial Area, Bhiwadi Extension, Dist. Alwar - 301025, Rajasthan, India
has been registered by Intertek as conforming to the requirements of
ISO 45001:2018

OHSAS 18001:2007 certified from 20 July 2017 to 27 February 2019.

The management system is applicable to:
Manufacture and Supply of uPVC & cPVC Pipes and Fittings and Solvent Cement for Industrial, Domestic, Agriculture, Sewage Applications.

Certificate Number: 0087730
Initial Certification Date: 20 July 2017
Date of Certification Decision: 27 February 2019
Issuing Date: 28 February 2019
Valid Until: 28 February 2022

UKAS
010

Cain Moldovean
President, Business Assurance
Intertek Certification Limited, 15A Victory Park, Victory Road, Derby DE24 0EJ, United Kingdom
Intertek Certification Limited is a UKAS accredited body under a schedule of accreditation no. 014



intertek
Test Quality. Assured.

CERTIFICATE OF REGISTRATION

This is to certify that the management system of
Ashirvad Pipes Pvt. Ltd.

Site 1: Plot No. 4-B, 26 & 26-B Attibele Industrial Area, Hosur Road, Bangalore - 562107, Karnataka, India
Site 2: Plot No. 27-F, 28-F, 29-F & 30, Bommasandra-Igani Link Road, Industrial Area, Igani Hobli, Anekal Taluk, Bangalore - 560055, Karnataka, India
Site 3: Plot No. SP1-177 & 178, Kalyani Industrial Area, Bhiwadi Extension, Dist. Alwar - 301025, Rajasthan, India
has been registered by Intertek as conforming to the requirements of
ISO 9001:2015

The management system is applicable to:
Manufacture and Supply of uPVC & cPVC Pipes and Fittings and Solvent Cement for Industrial, Domestic, Agriculture, Sewage Applications.

Certificate Number: 0087731
Initial Certification Date: 20 April 2013
Date of Certification Decision: 27 February 2019
Issuing Date: 28 February 2019
Valid Until: 28 February 2022

UKAS
010

Cain Moldovean
President, Business Assurance
Intertek Certification Limited, 15A Victory Park, Victory Road, Derby DE24 0EJ, United Kingdom



intertek
Test Quality. Assured.

CERTIFICATE OF REGISTRATION

This is to certify that the management system of
Ashirvad Pipes Pvt. Ltd.

Site 1: Plot No. 4-B, 26 & 26-B Attibele Industrial Area, Hosur Road, Bangalore - 562107, Karnataka, India
Site 2: Plot No. 27-F, 28-F, 29-F & 30, Bommasandra-Igani Link Road, Industrial Area, Igani Hobli, Anekal Taluk, Bangalore - 560055, Karnataka, India
Site 3: Plot No. SP1-177 & 178, Kalyani Industrial Area, Bhiwadi Extension, Dist. Alwar - 301025, Rajasthan, India
has been registered by Intertek as conforming to the requirements of
ISO 14001:2015

The management system is applicable to:
Manufacture and Supply of uPVC & cPVC Pipes and Fittings and Solvent Cement for Industrial, Domestic, Agriculture, Sewage Applications.

Certificate Number: 0087732
Initial Certification Date: 20 July 2017
Date of Certification Decision: 27 February 2019
Issuing Date: 28 February 2019
Valid Until: 28 February 2022

UKAS
010

Cain Moldovean
President, Business Assurance
Intertek Certification Limited, 15A Victory Park, Victory Road, Derby DE24 0EJ, United Kingdom



भारतीय मानक ब्यूरो
BUREAU OF INDIAN STANDARDS
बंगलुरु शाखा कार्यालय
BENGALURU BRANCH OFFICE

Address: Peenya Industrial Area, 1st Stage, Bangalore-Tumkur Road, Bangalore-560058
Phones: 080-28394955, 28394956
Fax: 080-28398841
E-mail: beb@bis.org.in
Web: http://www.bis.org.in

ENDORSEMENT FOR CHANGES IN THE LICENCE

ATTACHMENT TO LICENCE NO. CML- 4773075

CML NO	NAME OF THE LICENSEE WITH ADDRESS	PRODUCT	IS NO
4773075	M/S. ASHIRVAD PIPES PRIVATE LIMITED UNIT-2, PLOT NO.27F,28F,29 & 30,BOMMASANDRA-JIGANI LINK ROAD,BANDENALLASANDRA,JIGANI, ANEKAL TALLUK, BANGALORE-560105 KARNATAKA	Unplasticized polyvinyl chloride (upvc) injection moulded fittings for soil and waste discharge system for inside and outside buildings including ventilation and rain water system	IS 14735 : 1999

ENDORSEMENT NO. 1 Dated 13/09/2016

Renewed for a further period of one year from Fifth September Two Thousand and Fifteen to Fourth June Two Thousand and Sixteen.

Other terms and conditions of Licence remain the same.

(A.K. Bhatnagar)
Scientist-F & Head

भारतीय मानक ब्यूरो
BUREAU OF INDIAN STANDARDS
बंगलुरु शाखा कार्यालय
BENGALURU BRANCH OFFICE

Address: Peenya Industrial Area, 1st Stage, Bangalore-Tumkur Road, Bangalore-560058
Phones: 080-28394955, 28394956
Fax: 080-28398841
E-mail: beb@bis.org.in
Web: http://www.bis.org.in

ENDORSEMENT FOR CHANGES IN THE LICENCE

ATTACHMENT TO LICENCE NO. CML- 4497178

CML NO	NAME OF THE LICENSEE WITH ADDRESS	PRODUCT	IS NO
4497178	M/S.ASHIRVAD PIPES PVT. LTD UNIT-2, PLOT NO.27F, 28F, 29 & 30, BOMMASANDRA-JIGANI LINK ROAD, BANDENALLASANDRA, JIGANI, ANEKAL TALUK, BANGALORE-560105 KARNATAKA	Upvc pipes for soil and waste discharge systems inside buildings including ventilation and rainwater system	IS 12592 : 1992

ENDORSEMENT NO. 6 Dated 12/09/2015

Renewed for a further period of one year from Seventh September Two Thousand and Fifteen to Sixth September Two Thousand and Sixteen.

Other terms and conditions of Licence remain the same.

(A.K. Bhatnagar)
Scientist-F & Head

About Aliaxis



Aliaxis group is a leading global manufacturer and distributor of plastic fluid handling systems used in residential, commercial and industrial buildings.

Head quartered in Brussels, Belgium. Aliaxis is present in over 45 countries, has more than 100 manufacturing and commercial entities and employs over 16,000 people.

Aliaxis leverages local and global knowledge of the industry as well as regulations and building habits to provide consistently excellent customer service through distribution partners to builders, installers, infrastructure contractors and others. The group is in the Indian plumbing and sanitary market through a partnership with Ashirvad Pipes since 2013.

Aliaxis at a glance



€ 3.1 billion
Revenue



120+
Distribution centres



1.400+
Injection machines



16.000+
Colleagues



45+
Countries



600+
Extruders



€ 87 million
Capex



80+
Manufacturing sites



10
Commercial brands

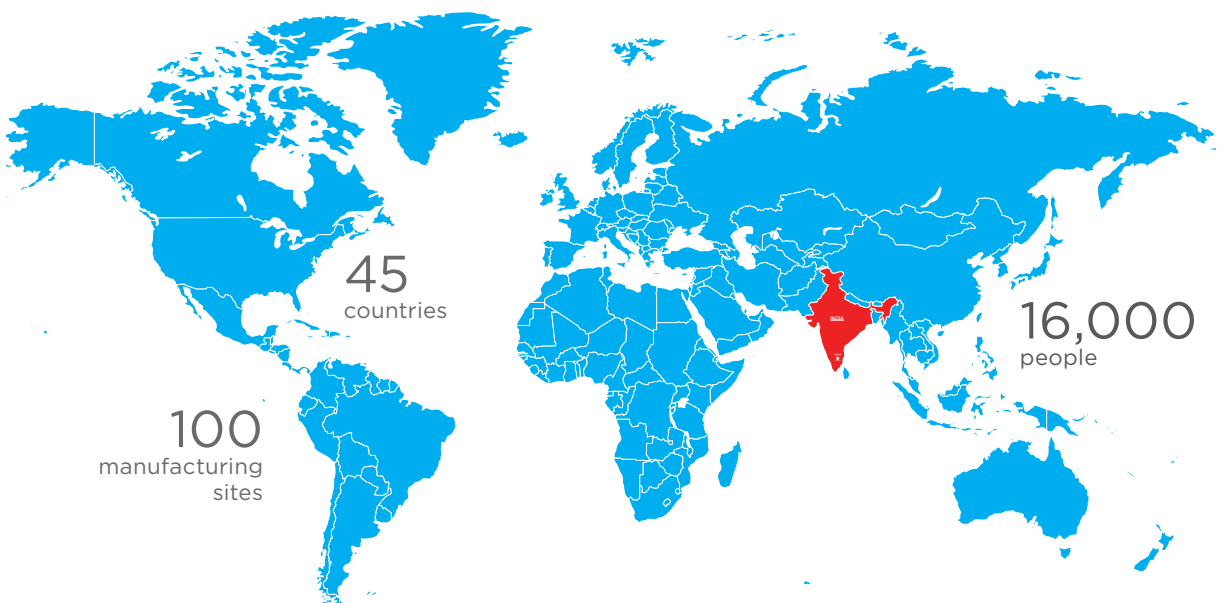





ASHIRVAD PIPES PVT. LTD.
ASHIRVAD PIPES PVT. LTD.

NO SMOKING
NO DRINKING
NO ENTRY
NO PARKING

NOTICE
1. No smoking
2. No drinking
3. No entry
4. No parking
5. No entry
6. No parking
7. No entry
8. No parking





Automated Raw material storage in Silos



Ashirvad workforce



SWR stock yard



Extrusion Facility

10 ASSURANCES

#01

STATE OF THE ART
MANUFACTURING FACILITIES

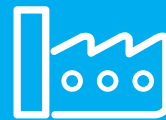

#02

ADVANCED MACHINERY
FOR SUPERIOR QUALITY

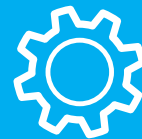

#03

ADVANCED MATERIAL
HANDLING SYSTEMS

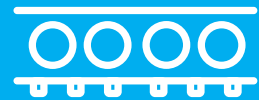

#04

100% INCOMING RAW
MATERIAL INSPECTION

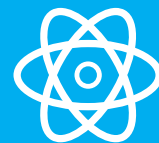

#05

HIGH DIMENSIONAL ACCURACY
TO MAINTAIN QUALITY OF
EACH PIECE, TO ENSURE
A DEFECT FREE SYSTEM



Ashirvad's stringent quality checks ensure premium products and maximum customer satisfaction

#06

STRINGENT QUALITY CHECKS AT EVERY LEVEL OF PRODUCTION

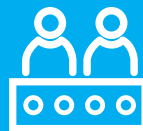

#07

EVERY BATCH OF PRODUCTS LAB TESTED



#08

100% FINISHED GOODS INSPECTION



#09

CHECKING OF GROOVES AND RINGS



#10

REGULAR EXTERNAL LAB TESTING OF PRODUCTS IN INDIA



LEAK PROOF BATHROOMS

Ideal for use in soil & waste water systems in villas and individual homes, residential apartments, office complexes, commercial buildings, hotels and hospitals.



About uPVC

Ashirvad offers an industry leading range of Solvent-fit and Push-fit Soil, Waste and Rain Water Plumbing Systems. These systems offer unparalleled installation options with high quality finish, superior dimensional accuracy, stability and are suitable for all commercial and domestic installations.

We offer fully accredited product systems. Ashirvad Pushfit and Solfit pipes are manufactured as per IS-13592 : 2013 and fittings as per IS-14735 : 1999. These systems are available in 40, 50, 63, 75, 90, 110, 140, 160, 200, 250 and 315 mm in solvent type and 75, 90, 110, 160, 200, 250 and 315 mm in ring/washer type.

The pipes are extruded on state-of-the-art extruders and are socketed on online bellong machines. The fittings are manufactured in collapsible core moulds to ensure straight sharp finish of the grooves for higher dimensional accuracy of the product which finally ensures the highest degree of fit, extended product life and product strength.

Ashirvad SWR Systems, therefore, offer unrivalled strength and product finish that provides a leak proof, maintenance free and long lasting solution to the customer.

All this is backed by extensive technical research to support all aspects of design and installation, including installation support and supply of required products.

Generic properties of uPVC are given below

Density [g/cm ³]	1.3 - 1.45
Thermal conductivity[w/(m.k)]	0.14 - 0.28
Yield strength [MPa]	31 - 60
Young's modulus [psi]	490,000
Flexural strength (yield) [psi]	10,500
Compression strength [psi]	9500
Coefficient of thermal expansion (linear) [mm(mm"°c)]	5×10^{-5}
Vicat [°c]	65 - 100
Resistivity [Qm]	10^{16}
Surface resistivity [Q]	$10^{13} - 10^{14}$

Fire resistant

Ashirvad SWR Systems are self-extinguishing and do not support combustion. They are therefore ideally suited for use in buildings and houses. uPVC must be forced to burn due to its high Limiting Oxygen Index (LOI) of 45. LOI is the percentage of oxygen needed in an atmosphere to support combustion. Since the Earth's atmosphere is only 21% oxygen, uPVC will not burn unless a flame is constantly applied, and stops burning when the ignition source is removed.

Material	LOI
Cotton	16 - 17
Polypropylene (PP)	18
Polyethylene (PE)	18
Wood	20
Atmospheric content of OXYGEN	21
PVC	45
CPVC	60

Chemical resistance of uPVC

Chemical 23°C 60°C
 (73°F) (140°F)

A

Acetaldehyde	N	N
Acetaldehyde, aq 40%	C	N
Acetamide - -	-	-
Acetic acid, vapor	R	R
Acetic acid, glacial	R	N
Acetic acid, 25%	R	R
Acetic acid, 60%	R	N
Acetic acid, 85%	R	N
Acetic anhydride	N	N
Acetone	N	N
Acetylene	N	N
Acetyl chloride	N	N
Acetylnitrile	N	N
Acrylonitrile	N	N
Acrylic acid	N	N
Adipic acid	R	R
Alcohol, allyl	R	C
Alcohol, amyl	N	N
Alcohol, benzyl	N	N
Alcohol, butyl (n-butanol)	R	R
Alcohol, diacetone	N	N
Alcohol, ethyl (ethanol)	R	R
Alcohol, hexyl (hexanol)	R	R
Alcohol, isopropyl (2-propanol)	R	R
Alcohol, methyl (methanol)	R	R
Alcohol, propyl (1-propanol)	R	R
Alcohol, propargyl	R	R
Allyl chloride	N	N
Alums	R	R
except Aluminim fluoride	R	N
Ammonia, gas	R	R
Ammonia, liquid	N	N
Ammonium salts	R	R

Chemical 23°C 60°C
 (73°F) (140°F)

except Ammonium Dichromate	R	N
Ammonium fluoride, 10%	R	R
Ammonium fluoride, 25%	R	C
Amyl acetate	N	N
Amyl chloride	N	N
Aniline	N	N
Aniline chlorohydrate	N	N
Aniline hydrochloride	N	N
Anthraquinone	R	R
Antimony trichloride	R	R
Anthraquinone sulfonic acid	R	R
Aqua regia	C	N
Arsenic acid, 80%	C	N
Aryl-sulfonic acid	R	R

B

Barium salts	R	R
except Barium nitrate	R	N
Beer	R	R
Beet sugar liquor	R	R
Benzaldehyde, 10%	R	N
Benzene (benzol)	N	N
Benzene sulfonic acid, 10%	R	R
Benzene sulfonic acid, > 10%	N	N
Benzoic acid	R	R
Black liquor – paper	R	R
Bleach, 12% active chlorine	R	R
Bleach, 5% active chlorine	R	R
Borax	R	R
Boric acid	R	R
Brine	R	R
Bromic acid	R	R
Bromine, aq	R	R
Bromine, liquid	N	N
Bromine, gas, 25%	R	R

Chemical	23°C (73°F)	60°C (140°F)
Bromobenzene	N	N
Bromotoluene	N	N
Butadiene	R	R
Butane	R	R
Butynediol	R	N
Butyl acetate	N	N
Butyl stearate	R	N
Butyl phenol	R	N
Butylene, liquid	R	R
Butyric acid	R	N
C		
Cadmium Cyanide	R	R
Calcium salts	R	R
except Calcium bisulde	N	N
Calcium hypochlorite, 30%	R	R
Calcium hydroxide	R	R
Calcium Nitrate	R	R
Calcium Oxide	R	R
Calcium Sulfate	R	R
Camphor	R	N
Cane sugar liquors	R	R
Carbon disulfide	N	N
Carbon dioxide	R	R
Carbon dioxide, aq	R	R
Carbon monoxide	R	R
Carbitol	R	N
Carbon tetrachloride	R	N
Carbonic Acid	R	R
Castor oil	R	R
Caustic potash (potassium hydroxide), 50%	R	R
Caustic soda (sodium hydroxide), <40%	R	R
Cellosolve	R	N
Cellosolve acetate	R	N
Chloral hydrate	R	R
Chloramine, dilute	R	N
Chloric acid, 20%	R	R
Chlorine, gas, dry	C	N

Chemical	23°C (73°F)	60°C (140°F)
Chlorine, gas, wet	N	N
Chlorine, liquid	N	N
Chlorine water	R	R
Chloroacetic acid, 50%	R	R
Chloroacetyl Chloride	R	N
Chlorobenzene	N	N
Chlorobenzyl chloride	N	N
Chloroform	N	N
Chloropicrin	N	N
Chlorosulfonic acid	R	N
Chromic acid, 10%	R	R
Chromic acid, 30%	R	R
Chromic acid, 40%	R	C
Chromic acid, 50%	N	N
Chromium potassium sulfate	R	N
Citric acid	R	R
Coconut oil	R	R
Coffee	R	R
Coke oven gas	R	R
Copper acetate	R	N
Copper salts, aq	R	R
Corn oil	R	R
Corn syrup	R	R
Cottonseed oil	R	R
Cresote	N	R
Cresol, 90%	N	N
Cresylic acid, 50%	R	R
Croton aldehyde	N	N
Crude oil, sour	R	R
Cupric Salts, aq	R	R
Cyclohexane	N	N
Cyclohexanol	N	N
Cyclohexanone	N	N
D		
Detergents, aq	R	R
Dextrin	R	R
Dextrose	R	R

Chemical	23°C (73°F)	60°C (140°F)
Dibutoxyethyl phthalate	N	N
Diesel fuels	R	R
Diethylamine	N	N
Diethyl Ether	R	N
Disodium phosphate	R	R
Diglycolic acid	R	R
Dioxane -1,4	N	N
Dimethylamine	R	R
Dimethyl formamide	N	N
Dibutyl phthalate	N	N
Dibutyl sebacate	R	N
Dichlorobenzene	N	N
Dichloroethylene	N	N

E

Ether	N	N
Ethyl ether	N	N
Ethyl halides	N	N
Ethylene halides	N	N
Ethylene glycol	R	R
Ethylene oxide	N	N

F

Fatty acids	R	R
Ferric salts	R	R
Fish Oil	R	R
Fluorine, dry gas	R	N
Fluorine, wet gas	R	N
Fluoboric acid	R	R
Fluosilicic acid, 50%	R	R
Formadehyde	R	R
Formic acid	R	N
Freon - F11, F12, F113, F114	R	R
Freon - F21, F22	R	N
Fructose	R	R
Furfural	N	N

G

Gallic acid	R	R
Gas, coal, manufactured	N	N
Gas, natural, methane	R	R

Chemical	23°C (73°F)	60°C (140°F)
Gasolines	C	C
Gelatin	R	R
Glucose	R	R
Glue, animal	R	R
Glycerine (glycerol)	R	R
Glycolic acid	R	R
Glycols	R	R
Grape Sugar	R	R
Green liquor, paper	R	R

H

Heptane	R	R
Hexane	R	N
Hexanol	R	R
Hydraulic Oil	R	N
Hydrobromic acid, 20%	R	R
Hydrochloric acid	R	R
Hydrofluoric acid, 30%	R	N
Hydrofluoric acid, 50%	R	N
Hydrofluoric acid, 100%	N	N
Hydrofluosilic acid	R	R
Hydrocyanic acid	R	R
Hydrogen	R	R
Hydrogen cyanide	R	R
Hydrogen fluoride	N	N
Hydrogen phosphide	R	R
Hydrogen peroxide, 50%	R	R
Hydrogen peroxide, 100%	R	R
Hydrogen sulfide, aq	R	R
Hydrogen sulfide, dry	R	R
Hydroquinone	R	R
Hydroxylamine sulfate	R	R
Hydrazine	N	N
Hypochlorous acid	R	R

I

Iodine, aq, 10%	N	N
-----------------	---	---

J

Jet fuels, JP-4 and JP-5	C	C
--------------------------	---	---

Chemical	23°C (73°F)	60°C (140°F)
K		
Kerosene	R	R
Ketones	N	N
Ketchup	R	N
Kraft paper liquor	R	R

L		
Lactic acid, 25%	R	R
Lactic acid, 80%	R	N
Lard oil	R	R
Lauric acid	R	R
Lauryl acetate	R	R
Lauryl chloride	R	R
Lead salts	R	R
Lime sulfur	R	R
Linoleic acid	R	R
Linoleic oil	R	R
Linseed oil	R	R
Liqueurs	R	R
Lithium salts	R	R
Lubricating oils	R	R

M		
Magnesium salts	R	R
Maleic acid	R	R
Malic acid	R	R
Manganese sulfate	R	R
Mercuric salts	R	R
Mercury	R	R
Methane	R	R
Methoxyethyl oleate	R	N
Methyl acetate	N	N
Methyl amine	N	N
Methyl bromide	N	N
Methyl cellosolve	N	N
Methyl chloride	N	N
Methyl chloroform	N	N
Methyl ethyl ketone	N	N
Methyl isobutyl carbinol	N	N
Methyl isopropyl ketone	N	N

Chemical	23°C (73°F)	60°C (140°F)
Methyl methacrylate	R	N
Methyl sulfate	R	N
Methyl sulfuric acid	R	R
Methylene bromide	N	N
Methylene chloride	N	N
Methylene iodide	N	N
Milk	R	R
Mineral oil	R	R
Molasses	R	R
Monochloroacetic acid	R	R
Monochlorobenzene	N	N
Monoethanolamine	N	N
Motor oil	R	R

N		
Naptha	R	R
Naphthalene	N	N
Natural Gas	R	R
Nickel acetate	R	N
Nickel salts	R	R
Nicotine	R	R
Nicotinic acid	R	R
Nitric acid, 0 to 40%	R	R
Nitric acid, 50%	R	C
Nitric acid, 100%	N	N
Nitrobenzene	N	N
Nitroglycerine	N	N
Nitrous acid, 10%	R	R
Nitrous oxide, gas	R	N
Nitroglycol	N	N

O		
Oleic acid	R	R
Oleum	N	N
Olive oil	R	R
Oxalic acid	R	R
Oxygen, gas	R	R
Ozone, gas	R	R

Chemical	23°C (73°F)	60°C (140°F)
P		
Palmitic acid, 10%	R	R
Palmitic acid, 70%	R	N
Paraffin	R	R
Pentane	C	C
Peracetic acid, 40%	R	N
Perchloric acid, 15%	R	N
Perchloric acid, 70%	r	N
Perchloroethylene	R	N
Perphosphate	R	N
Phenol	R	N
Phenylhydrazine	N	N
Phosphoric anhydride	R	N
Phosphoric acid	R	R
Phosphorus pentoxide	R	N
Phosphorous trichloride	N	N
Photographic chemicals, aq	R	R
Phthalic acid	N	N
Plating solutions, metal	R	R
Potash	R	R
Potassium amyl xanthate	R	N
Potassium salts, aq	R	R
except Potassium iodide	R	N
Potassium permanganate, 10%	R	R
Potassium permanganate, 25	R	N
Propane	R	R
Propylene dichloride	N	N
Propylene oxide	N	N
Pyridine	N	N
Pyrogallic acid	R	N
R		
Rayon coagulating bath	R	R
S		
Salicylic acid	R	R
Salicyladehyde	N	N
Selenic acid, aq.	R	R
Silicic acid	R	R
Silicone oil	R	N

Chemical	23°C (73°F)	60°C (140°F)
Silver salts	R	R
Soaps	R	R
Sodium salts, aq	R	R
except Sodium chlorite	N	N
except Sodium chlorate	R	N
except Sodium hypochlorite	R	N
Stannic chloride	R	R
Stannous chloride	R	R
Starchy	R	R
Stearic acid	R	R
Stoddard solvent	N	N
Succinic acid	R	R
Sulfamic acid	N	N
Sulfate & Sulfite liquors	R	R
Sulfur	R	R
Sugars, aq	R	R
Sulfur dioxide, dry	R	R
Sulfur dioxide, wet	R	N
Sulfur trioxide, gas, dry	R	R
Sulfur acid, wet	R	N
Sulfuric acid, up to 80%	R	R
Sulfuric acid, 90 to 93%	R	N
Sulfuric acid, 94 to 100%	N	N
Sulfurous acid	R	R
T		
Tall oil	R	R
Tannic acid	R	R
Tanning liquors	R	R
Tar	N	N
Tartaric acid	R	R
Terpineol	C	C
Tetrachloroethane	C	C
Toluene	N	N
Tomato juice	R	R
Transformer oil	R	R
Tributyl phosphate	N	N
Tributyl citrate	R	R
Trichloroacetic acid	R	R

Chemical	23°C (73°F)	60°C (140°F)
Trichloroethylene	R	N
Triethanolamine	R	N
Triethylamine	R	R
Trimethyl propane	R	N
Trisodium phosphate	R	R
Turpentine	R	R

U

Urea	R	R
Urine	R	R

V

Vaseline	N	N
Vegetable oils	R	R
Vinegar	R	R
Vinyl acetate	N	N

W

Water, deionized	R	R
Water, distilled	R	R
Water, salt	R	R
White Liquor	R	R
Whiskey	R	R
Wines	R	R

X

Xylene	N	N
--------	---	---

Z

Zinc salts	R	R
------------	---	---

These tables are meant to aid the designer in decisions as to transporting/conveyance of undiluted chemicals. Chemical resistance data is provided as a guide only. Information is based primarily on immersion of unstressed strips in chemicals and to lesser degree on field experience.

Source: PPI TR-19 Plastics Institute Wayne, NJ, 1991; Uni-Bell Handbook of PVC pipe.



Why only Ashirvad SWR?

Having pioneered the development of CPVC and Column Pipes in India, Ashirvad Pipes launched a new range of SWR Systems Plumbing products at par with international quality standards. Ashirvad products represent the industry benchmark for quality, installation, flexibility and product innovation backed by the highest levels of customer service.

Ashirvad SWR systems include an extensive range of Soil, Waste and Rain Water Plumbing products for commercial, industrial, housing and public sector developments, all built on the strength of our quality and innovation. Ashirvad systems include solvent-weld and push-fit options for both soil, waste and rain water drainage: a comprehensive range of products and accessories.

Industry leading and world class range of solvent and push-fit soil and waste solutions offer unrivalled installation options, high quality finish, superior technology and are suitable for all types of commercial and domestic installations.



Quick, easy and convenient installation

Ashirvad SWR systems are light in weight which reduces the transportation, handling and installation costs.



Corrosion and abrasion resistance

Ashirvad SWR pipes have excellent corrosion resistance. Maintenance free Ashirvad SWR Pipes and fittings do not rust, corrode or promote build-up of deposits in the system interior.



Smooth Interior - free of incrustations

The smooth interior of Ashirvad SWR Pipes and fittings prevents the build-up of deposits, assuring low friction loss and ensuring high flow rates. The high flow rate continues for the life of the piping system.



Tough and reliable

Special formulation - high strength, optimum surface shine and finish. High operating life.



Cost effective

The many advantages of Ashirvad SWR system ensures a lower capital, installation, maintenance cost compared to other piping systems.

FEATURES AND BENEFITS OF ASHIRVAD SWR

- Complete SWR range of pipes and fittings - 40, 50, 63, 75, 90, 110, 140, 160, 200, 250 and 315 mm
- 100% leak proof joints
- Unparalleled strength and performance
- High degree of dimensional accuracy, ensuring optimum quality
- UV stabilized
- High chemical resistance
- Special formulation high strength, optimum surface shine and finish, high operating life
- Light weight - The low weight of the system makes it easy to install and reduces transportation, handling and installation costs.
- Aesthetic appearance

Applications of Ashirvad SWR systems

- Piping for soil discharge
- Waste discharge
- Venting of gases / smells / bad odors
- Non pressure industrial drainage application (based on chemical compatibility)
- Rain water transportation
- Domestic & commercial drainage
- Replacement of cast iron piping
- Laboratory drainage (based on chemical compatibility)

About Yellow Seal™

First time in India, advanced co-moulding technology at par with International Standards

Ashirvad introduces Yellow Seal™, the advanced co-moulding technology for the first time in India which is at par with International Quality Standards. It consists of a plastic reinforced rubber ring which holds the Yellow Seal™ in the groove ensuring 100% leak proof joint, at the same time providing adequate scope for thermal expansion/contraction.

It enables the joint to withstand high pressure flow rates. Unlike conventional rubber rings which slip out of the groove during installation, the Yellow Seal™ stays attached to the groove by the plastic reinforcement making the joint 100% leak proof.

Since the joint does not involve solvent adhesive, it can be re-opened to adjust and realign. The coefficient of linear expansion for uPVC is 0.06mm/m/°C. As a result a 3m length of pipe will increase in length by approximately 3.6mm when subjected to a 20°C temperature variation.

Therefore, it is important to ensure that and ring seal joints are installed to accommodate any expansion that may occur due to increases in ambient temperature or hot water discharges. The Yellow Seal™ enables this movement in the joint and prevents breakages in the long run.









Why only Pushfit?

Ashirvad Pushfit Pipes and Fittings are manufactured as per IS 13592 : 2013 and IS 14735 : 1999 in 75, 90, 110, 160, 200, 250 & 315 mm. This system comes with a pre-fitted rubber (Yellow Seal™) in the groove that ensures a leak proof joint. The system is joined by simply pushing the spigot end into the socket end.

This requires no threading or solvent adhesive. The spigot end is held firmly in the socket with the help of the Yellow Seal™. It ensures a leak proof joint and can withstand high pressure flow. This system is made in high tech, new generation machines and offers unrivalled performance, strength and finish.

The advanced Yellow Seal™ enables the joints to not only withstand high pressure and provide leak proof joints but also caters to the thermal expansion and contraction of plastic. Since the joint is not fixed by solvent adhesive, it can be reopened after several hours of installation to realign, change or adjust the pipe/fitting.



Quick, easy and convenient installation



Corrosion and abrasion resistance



Smooth Interior - free of incrustations



Tough and reliable



Cost effective

Physical and Mechanical properties

THERMAL EXPANSION

uPVC has a coefficient of expansion of approximately 0.06mm/m/°C. Consequently a 2m length of soil or waste pipe will expand by 2.4 mm for a 20°C rise in temperature. This expansion is taken into consideration in the design of systems and components, and must be accommodated when installing. It is important that this movement be allowed by including an expansion gap at ring seal joints. The spigot should be pushed fully into the ring seal socket, marked at the socket face, and then withdrawn by 10 mm. A subsequent check should be made to ensure that the expansion gap is not lost during further installation work.

Typical Ring Seal Joint

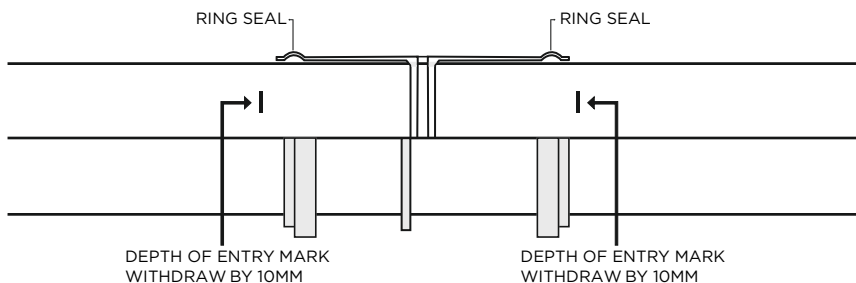

ADVANTAGES OF ASHIRVAD PUSHFIT SYSTEMS

- 100% leak proof joints
- Collapsible core moulds - ultra modern technology of molding fittings
- Simply pushfit to make joint - saves on installation time, easy to install
- No solvent adhesive required for making joints - cost effective
- Can be removed or opened - for any adjustment, changes
- Ring does not fall out and allows for thermal expansion and contraction of plastic
- No dimensional variation
- No blowing of fittings to create groove
- High pressure bearing capacity - joint pressure tested at 5 kg/cm²
- High flow rates - no choking

Technical specification for Pushfit System

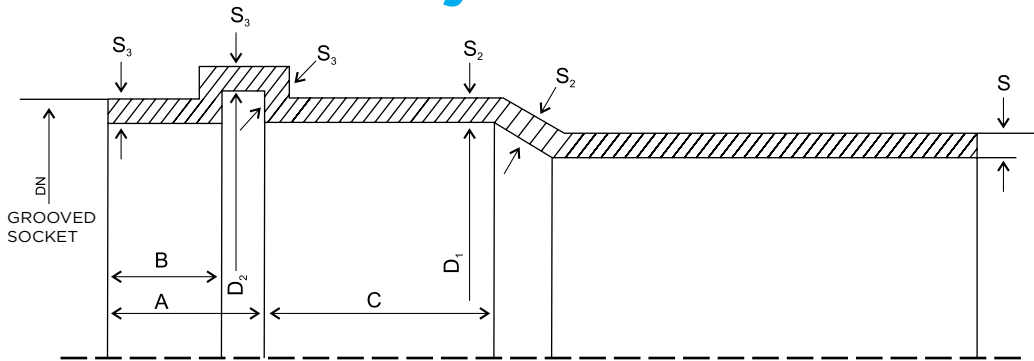

Dimensions of pipes

Nominal Outside Diameter DN (mm)	Mean Outside Diameter (mm)		Outside Diameter at Any Point (mm)		Wall Thickness, S Type A (mm)		Wall Thickness, S Type B (mm)	
	Min	Max	Min	Max	Min	Max	Min	Max
75	75.0	75.3	74.1	75.9	1.8	2.2	3.2	3.8
90	90.0	90.3	88.9	91.2	1.9	2.3	3.2	3.8
110	110.0	110.4	108.6	111.4	2.2	2.7	3.2	3.8
160	160.0	160.5	158.0	162.0	3.2	3.8	4.0	4.6
200	200.0	200.6	197.6	202.4	-	-	4.9	5.6
250	250.0	250.8	247.0	253.0	-	-	6.2	7.1
315	315.0	316.0	311.2	318.8	-	-	7.7	8.7

Maximum wall thickness of sockets of pipes

Nominal Outside Diameter DN (mm)	S2, Min (mm)		S3, Min (mm)	
	Type A	Type B	Type A	Type B
75	1.6	2.9	1.0	2.4
90	1.7	2.9	1.1	2.4
110	2.0	2.9	1.2	2.4
160	2.9	3.6	1.8	3.0
200	-	4.4	-	3.7
250	-	5.5	-	4.7
315	-	6.9	-	5.8

Dimensions of grooved socket

Nominal Outside Diameter DN (mm)	Inside Diameter of Socket, D1 (mm)		Inside Diameter of Beading, D2 (mm)		Length of Beading and Neck (mm)	Neck of Socket (mm)	Length Beyond Beading (mm)
	Min	Max	Min	Max	A	B	C
75	75.3	76.2	84.5	85.5	20	5	25
90	90.3	91.2	99.5	100.5	23	5	28
110	110.4	111.3	120.3	121.3	26	6	32
160	160.5	161.5	173.8	175.0	32	9	42
200	200.6	201.8	214.0	215.4	40	15	50
250	250.8	252.0	264.0	265.4	70	15	55
315	316.0	317.2	329.0	330.4	70	15	62

Why only Solfit?

Ashirvad Solfit Pipes and Fittings are manufactured as per IS 13592 : 2013 and IS 14735 : 1999 in 40, 50, 63, 75, 90, 110, 140, 160, 200, 250 and 315 mm. Ashirvad Solfit systems are joined by solvent adhesive. This system is made by new generation high tech machines and offers unrivalled performance, strength and finish.



100% leak proof joints



High flow rates - no choking



High degree of dimensional accuracy



Cost effective

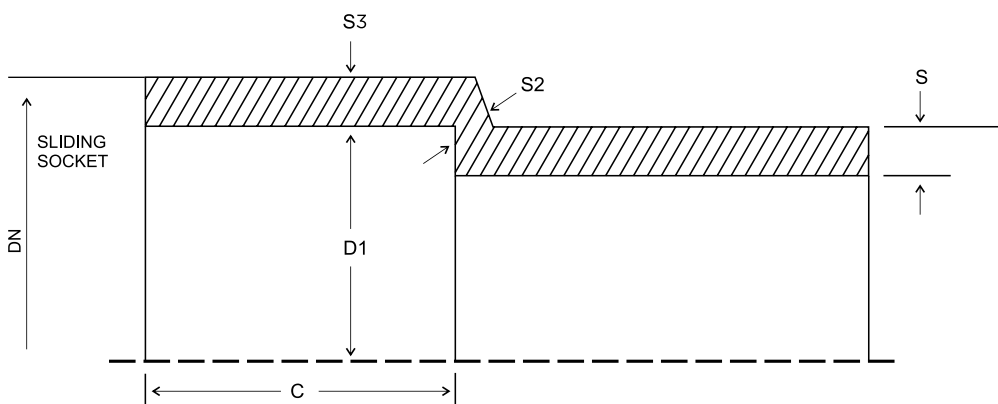

Technical specification for Solfit System

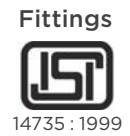

Dimensions of pipes

Nominal Outside Diameter DN (mm)	Mean Outside Diameter (mm)		Outside Diameter at Any Point (mm)		Wall Thickness, S Type A (mm)		Wall Thickness, S Type B (mm)	
	Min	Max	Min	Max	Min	Max	Min	Max
40	40.0	40.3	39.5	40.5	1.8	2.2	3.2	3.8
50	50.0	50.3	49.4	50.6	1.8	2.2	3.2	3.8
63	63.0	63.3	62.2	63.8	1.8	2.2	3.2	3.8
75	75.0	75.3	74.1	75.9	1.8	2.2	3.2	3.8
90	90.0	90.3	88.9	91.2	1.9	2.3	3.2	3.8
110	110.0	110.4	108.6	111.4	2.2	2.7	3.2	3.8
140	140.0	140.5	138.3	141.7	2.9	3.4	3.6	4.2
160	160.0	160.5	158.0	162.0	3.2	3.8	4.0	4.6
200	200.0	200.6	197.6	202.4	-	-	4.9	5.6
250	250.0	250.8	247.0	253.0	-	-	6.2	7.1
315	315.0	316.0	311.2	318.8	-	-	7.7	8.7

Maximum wall thickness of sockets of pipes

Nominal Outside Diameter DN (mm)	S2, Min (mm)		S3, Min (mm)	
	Type A	Type B	Type A	Type B
40	1.6	2.9	1.0	2.4
50	1.6	2.9	1.0	2.4
63	1.6	2.9	1.0	2.4
75	1.6	2.9	1.0	2.4
90	1.7	2.9	1.1	2.4
110	2.0	2.9	1.2	2.4
140	2.6	3.2	1.6	2.7
160	2.9	3.6	1.8	3.0
200	-	4.4	-	3.7
250	-	5.5	-	4.7
315	-	6.9	-	5.8

Dimensions for socket for solvent adhesive

Nominal Outside Diameter DN (mm)	Socket Depth, C (mm)	Mean Inside Diameter of Socket at Midpoint, D1	
		Min	Max
40	26	40.1	40.3
50	30	50.1	50.3
63	36.0	63.1	63.3
75	40.0	75.1	75.3
90	46.0	90.1	90.3
110	48.0	110.1	110.4
140	54.0	140.2	140.5
160	58.0	160.2	160.5
200	60.0	200.3	200.6
250	60.0	250.4	250.8
315	60.0	315.4	316.0

SMART WATER MANAGEMENT

With technical tie ups from across the globe, Ashirvad strives to bring the latest technology, products and solutions into the Indian plumbing market, with more and more satisfied customers each day.



Quality Control Procedures at Ashirvad

The pipes and fittings manufactured at Ashirvad, follow a stringent quality control process before being rolled out into the market, in order to supply a defect free system to its users.

These processes follow the highest specifications of BIS (India).

FOR PIPES



Dimensions

To ensure that all pipe dimensions, particularly wall thickness and outer diameter (roundness), conform to the appropriate standards.



Flattening Test

Samples are compressed so that opposite walls are brought together without the pipe cracking, which is a good measure of correct extrusion techniques during production.



Drop Impact Test

Weights are dropped on the pipe to observe any cracks or failures.



Heat Reversion Test

How much the pipe changes in length when heated in an oven and left to cool. This is a measure of residual stresses left in the pipe during production process.



Tensile Strength

To find out the maximum stress that our pipe sample can withstand while being stretched or pulled before breaking OR To check the ability of a material to withstand a pulling force.



Stress Relief Test

Test test specimens pipe must not show blisters,excessive de-lamination or cracking or signs of weld line splitting after keeping under specified temperature (150 degree Celsius) and specified time duration in air oven or immersion method.



Vicat Softening Temperature (VST)

To find out the softening point of the material, it is the temperature at which the specimen is penetrated to a depth of 1 mm by a flat-ended needle with a 1 mm² circular or square cross-section. OR, at a temperature at which the 1 mm² needle will penetrate the hot sample upto 1 mm depth, under a specified load.



Water Tightness of Joint

To ensure the pipe joints are free from leakage when applying internal hydrostatic pressure.



Effect of Sunlight

To check the effect of sunlight on pipes by expose the sample in sunlight for 1600 hours and compare the initial & exposed sample for any physical property changes.

OTHER TESTS

- Tensile Strength
- Opacity
- VST
- Density



Resistance to H₂SO₄

To check the resistance of pipes with concentrated sulphuric acid.



Axial Shrinkage

To check the percentage change in length or shrinkage of pipes and tested at 90° C.



Resistance to Dicloromethane at specified Temperature

To check the gelation in pipes, after conducting this test sample should not show any sign of attack.

FOR FITTINGS



Dimensions Check

To ensure that fittings have correct dimensions, particularly wall thickness, socket diameters and socket depth.



Drop Impact Test

To check the mechanical property of fittings by dropping freely, in random position from a specified height and temp, on to a flat concrete floor.



Stress Relief Test

Test test specimens fitting must not show blisters,excessive de-lamination or cracking or signs of weld line splitting after keeping under specified temperature (150 degree Celsius) and specified time duration in air oven or immersion method.



Vicat Softening Temperature (VST)

To find out the softening point of the material, It is the temp. at which the specimen is penetrated to a depth of 1 mm by a flat-ended needle with a 1 mm² circular or square cross-section. OR, at a temperature at which the 1 mm² needle will penetrate the hot sample upto 1 mm depth, under a specified load.



Resistance to H₂SO₄

To check the resistance of fittings with concentrated sulphuric acid.



Water Tightness of Joint

To ensure the fittings joints are free from leakage when applying internal hydrostatic pressure.

TiO₂ ?

Titanium Dioxide Content Test

To determine the weathering property of fittings by checking the percentage of titanium dioxide present in fittings.

ASH ?

Sulphated Ash Content Test

The sulfated ash test uses a procedure to measure the amount of residual substance not volatilized from a sample when the sample is ignited in the presence of sulphuric acid. The test is usually used for determining the content of inorganic impurities in an organic substance.

Handling and Storage

Proper Handling



Please check and inspect the pipes on receipt. The pipes should be checked for any forms of transport damage due to shift in loads or improper handling/treatment. Visually examine the ends of pipes for any cracks or damage.



The pipes should be handled with care. The tendency to throw or drop the pipes to the floor should be avoided. Do not drag or push the pipes from a truck bed. Contact of pipes with from any sharp object should be totally avoided.

Storage of Pipes

The pipes should preferably be stored indoors. When this is not possible, please ensure to:



- Protect the pipes from sun light, to reduce the effect of UV rays.

- Store on level ground and dry surface.

- If pipes of same diameter but different classes are being stacked together, place the thicker pipes below. i.e., Stack type B below type A. If placing pipes on racks, ensure the spacing between the supports does not exceed 3 feet.



- Donot store pipes on metal surfaces exposed to sunlight or reflective.

Correct Transportation procedure



Where possible use a truck for deliveries. Lay pipe flat on the tray.



Keep pipe strapped down so it doesn't roll around and remains supported.



Alternate socket and pipe ends when loading pipe.

Safe Handling of Solvents

When using solvent adhesive there are some basic safety measures all users should keep in mind.



- After every application of solvent on the pipe / fitting ensure to put the lid back on the solvent adhesive containers and tighten the lid slightly to avoid evaporation and escape of solvent.



- Avoid prolonged breathing of solvent vapours. When pipe and fittings are being joined in enclosed areas, please ensure sufficient ventilation.



- Keep the adhesive away from all sources of ignition, heat, sparks and open flame.



- Keep containers of adhesive tightly closed except when the product is being used.

- Dispose of all rags used with solvents in a proper outdoor waste bin.



- Avoid eye and skin contact. In case of eye contact, flush with plenty of water for 15 minutes and call a doctor.

Installation Guide for Pushfit

Easy and 100% leakproof installation.

Step 1: Cutting

Measure and cut pipe to size. Ensure to cut the pipes straight and square. Inspect pipe ends thoroughly before making the cut, if any cracks or split in the ring is noticed cut off a minimum of 25 mm beyond the visible crack before proceeding.

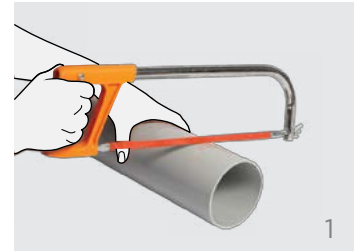

Step 2: Chamfering and Deburring

Burrs in and on pipe end can obstruct flow/proper contact between the pipe and socket of the fitting during assembly and should be removed from both in and outside of the pipe. A 15 mm dia half round file/a pen knife or a deburring tool are suitable for this purpose. A slight bevel on the end of the pipe will ease entry of the pipe into the socket of the fitting socket.

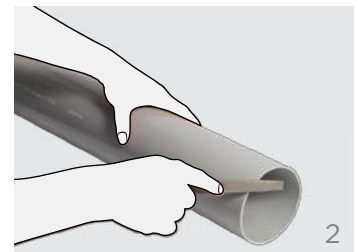

Step 3: Fitting Preparation

Use a clean dry cloth to wipe the dirt, moisture from the fitting and pipe end.

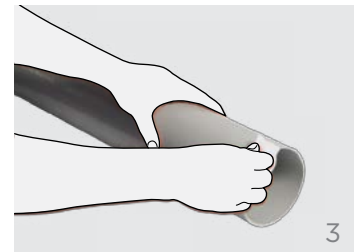

Step 4: Check for Yellow Seal™

Check the socket end for Yellow Seal™. Ensure that the yellow part of the seal is towards the outside of socket.

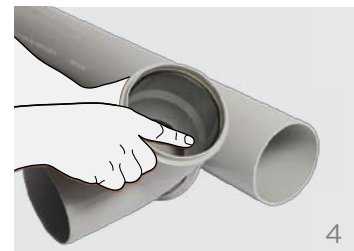

Step 5: Lubricant

Apply the lubricant on the chamfered end of the pipe.

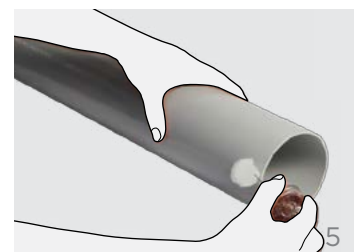

Step 6: Assembly

Immediately insert the pipe into the fitting socket. Rotate the pipe slightly while inserting. Withdraw pipe until the mark is 12 mm away from socket. This means a 12 mm gap exists between the end of the pipe and the socket register. This gap will allow the pipe to expand without distorting the pipe-work jointing.

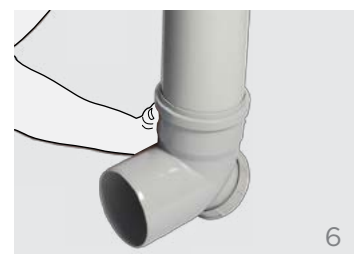

ASHIRVAD PUSHFIT Pipes and Fittings are joined with the help of Ashirvad SWR Lubricant. For faster plumbing and leak proof joints we strongly recommend the use of Ashirvad lubricants only.

Installation Guide for Solfit

Easy and 100% leakproof installation.

Step 1: Cutting

Measure the pipe length accurately and make a visible marking using a felt tip pen. Ensure that the pipe and fittings are size compatible. You can easily cut with a plywood cutting saw/ ratchet cutter or a wheel cutter. Cutting the pipe as squarely as possible (at 90°) provides optimal bonding area within a joint. Inspect pipe ends thoroughly prior to making a joint. If a crack or splintering is noticed cut-off a minimum of 25 mm beyond the visible crack before proceeding.



Step 2: Deburring/Beveling

Burrs in and on pipe end can obstruct flow/proper contact between the pipe and socket of the fitting during assembly and should be removed from both in and outside of the pipe. A 15 mm dia half round file/a pen knife or a deburring tool are suitable for this purpose. A slight bevel on the end of the pipe will ease entry of the pipe into the socket of the fitting socket.

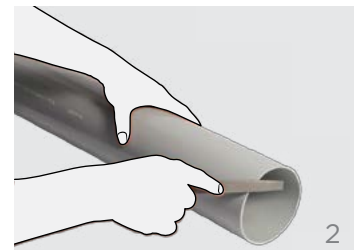

Step 3: Fitting Preparation

Using a clean dry rag, wipe the dirt and moisture from the fitting sockets and pipe end. Dry fit the pipe to ensure total entry into the bottom of the fittings socket and make a visible marking using a felt tip pen.

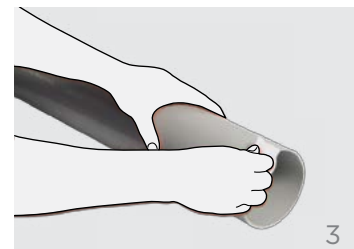

Step 4: Solvent Adhesive Application

Apply an even coat of solvent adhesive on the pipe and the socket end of the fitting. Do not use thickened or lumpy solvent adhesive. It should have a flow consistency like that of syrup or paint.

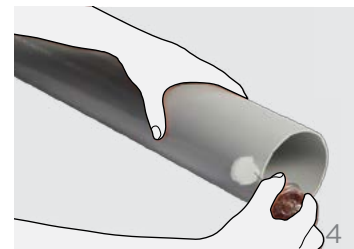

Step 5: Assembly

Immediately insert the pipe into the fitting socket, rotate the pipe ¼ to ½ turn while inserting. This motion ensures an even distribution of adhesive within the joint. Hold the assembly for 10 seconds to allow the joint to setup.

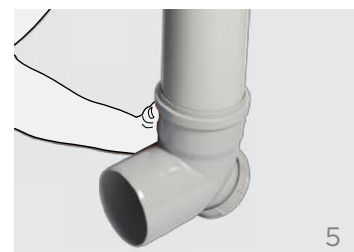

ASHIRVAD SOLFIT Pipes and Fittings are joined with the help of Ashirvad SWR solvent adhesive, which is a single step fast setting solvent adhesive. The bonding takes place due to chemical fusion of the mating surfaces.

Installation Guide and Tips

Horizontal suspended pipes

As plastic is subject to thermal movement, we recommend that the pipe sockets are held firmly by brackets to prevent them from moving.

This ensures that any thermal movement is taken up in the expansion coupling, preventing buckling of the pipe between the supports. Please note that intermediate pipe brackets are for support only and must not restrict movement.

The British Standard BS EN 12056-2:2000 recommends that pipe should be supported at the following intervals.

Material	Pipe Diameter (mm)	Horizontal (m)	Vertical (m)
Unplasticized polyvinyl chloride (uPVC)	40	0.5	1.2
	50	0.5	1.5
	63	0.7	1.5
	75	0.8	2.0
	90	0.9	2.0
	110	1.1	2.0
	140	1.4	2.0
	160	1.6	2.0
	200	2.0	2.5
	250	2.0	2.5
315	2.0	2.5	

Ventilation of soil and waste system

Ventilation of a soil and waste system is necessary to prevent water seals in traps being broken due to negative pressure or pressure fluctuations within the system.

Broken seals permit foul air and smells to escape from the system, contaminating the air in and around the building. There are two ways of ventilating a soil stack, either externally to the atmosphere, or with an Air Admittance Valve seated in a non- inhabited space within a building.

The termination of an externally vented system must comply with the dimensional requirements illustrated in the diagram shown below.

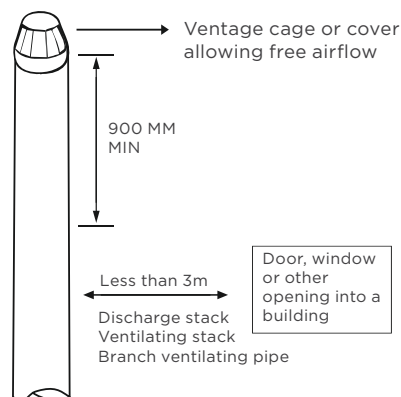

Testing of System

A smoke test or water test is generally done to ensure SWR systems are installed correctly.

Water Test

A water or hydrostatic test is generally used to inspect a completed plastic piping system installation and is the testing procedure recommended by Ashirvad. It is also the most recommended test in most plumbing code standards. The purpose of the test is to locate any leaks at the joints and correct them prior to putting system into operation. Since it is important to be able to visually inspect the joints, a water test should be conducted prior to closing in the piping or backfilling behind the wall/floor.

To isolate each floor or section being tested, test plugs are inserted through test fittings in the stack. All other openings should be plugged or capped with test plug or test caps. Fill the system to be tested with water at the highest point. As water fills a vertical pipe it creates hydrostatic pressure. The pressure increases as the height of water in the vertical pipe increases. Ashirvad recommends testing at 5m of hydrostatic pressure (0.5 kg/cm²) or as per the local authority's guidelines. Filling the system slowly should allow any air in the system to escape as the water rises in the vertical pipe. All entrapped air in the system should be expelled for proper test result.

Once the stack is filled to desired level of water column, a visual inspection of the section being tested should be made to check for leaks. If a leak is found, corrective actions must be taken up to find the cause of leak and to repair or replace the joint. Fifteen minutes is a suitable time for the water test. Once the system has been successfully tested, it should be drained and the next section prepared for testing.

Preparing the pipeline for test

- All joints should be inspected to ensure the correct location of the mark or groove to the coupling socket.
- Check that minimum cure time has elapsed since the last solvent adhesive joint has been worked on.
- Check the tightness of all ties and clamps and correct positioning of piping.



SWR systems are classed as non - pressure and so are intrinsically gravity flow in nature.

Product Dimensions: Pushfit Fittings

PLAIN BEND

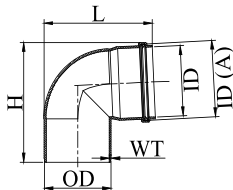

Size (in)	Size (mm)	Socket ID	Groove ID (A)	Spigot OD	WT	H	L
2½	75	76.2	84.5	75.3	3.2	145	137
3	90	91.2	100.5	90.3	3.2	169	164
4	110	111.3	121.3	110.4	3.2	196	191
6	160	161.5	175.0	160.5	4.0	275	268
8	200	201.3	217.0	200.2	4.6	326	308

COUPLER

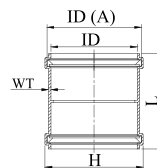

Size (in)	Size (mm)	Socket ID	Groove ID (A)	WT	H	L
2½	75	76.2	84.5	3.2	90	109
3	90	91.2	100.5	3.2	106	131
4	110	111.3	121.3	3.2	126	147
6	160	161.5	175.0	4.0	182	196
8	200	201.3	217.0	4.6	197	226

DOOR BEND

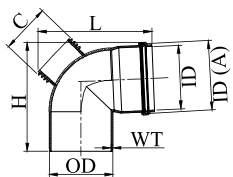

Size (in)	Size (mm)	Socket ID	Groove ID (A)	Spigot OD	WT	C	H	L
2½	75	76.2	84.5	75.3	3.2	75	152	151
3	90	91.2	100.5	90.3	3.2	90	175	177
4	110	111.3	121.3	110.4	3.2	110	204	206
6	160	161.5	175.0	160.5	4.0	110	275	270
8	200	201.3	217.0	200.2	4.6	160	326	322

REPAIR COUPLER

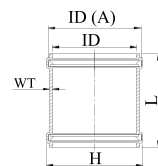

Size (in)	Size (mm)	Socket ID	Groove ID (A)	WT	H	L
2½	75	76.2	84.5	3.2	90	109
3	90	91.2	100.5	3.2	106	131
4	110	111.3	121.3	3.2	118	103
6	160	161.5	175.0	4.0	182	196
8	200	201.3	217.0	4.6	197	226

BEND 45°

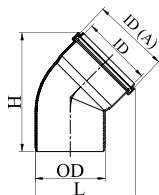

Size (in)	Size (mm)	Socket ID	Groove ID (A)	Spigot OD	WT	H	L
2½	75	76.2	84.5	75.3	3.2	157	124
3	90	91.2	100.5	90.3	3.2	185	142
4	110	111.3	121.3	110.4	3.2	211	168
6	160	161.5	175.0	160.5	4.0	290	209
8	200	201.3	217.0	200.2	4.6	313	280

REDUCER

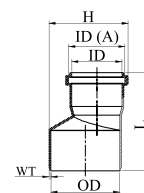

Size (in)	Size (mm)	Groove ID (A)	Socket ID	WT	H	L	
3x2½	90x75	84.5	90.3	76.2	3.2	90	133
4x2½	110x75	84.5	110.4	76.2	3.2	117	150
4x3	110x90	100.5	110.4	91.2	3.2	117	153
6x4	160x110	121.3	160.5	111.3	4.0	187	207
8x6	200x160	175.0	200.2	160.5	4.6	214	210

SINGLE TEE

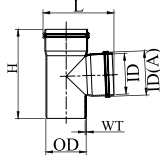

Size (in)	Size (mm)	Socket ID	Groove ID (A)	Spigot OD	WT	H	L
2½	75	76.2	84.5	75.3	3.2	194	138
3	90	91.2	100.5	90.3	3.2	228	164
4	110	111.3	121.3	110.4	3.2	262	193
6	160	161.5	175.0	160.5	4.0	364	269
8	200	201.3	217.0	200.2	4.6	416	315

CLEANING PIPE

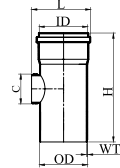

Size (in)	Size (mm)	Socket ID	Groove ID (A)	Spigot OD	WT	C	H	L
2½	75	76.2	84.5	75.3	3.2	75	193	100
3	90	91.2	100.5	90.3	3.2	90	228	118
4	110	111.3	121.3	110.4	3.2	110	262	146
6	160	161.5	175.0	160.5	4.0	110	318	189

DOOR TEE

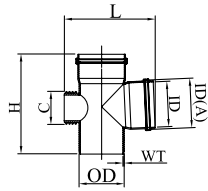

Size (in)	Size (mm)	Socket ID	Groove ID (A)	Spigot OD	WT	C	H	L
2½	75	76.2	84.5	75.3	3.2	75	194	163
3	90	91.2	100.5	90.3	3.2	90	228	192
4	110	111.3	121.3	110.4	3.2	110	262	222
6	160	161.5	175.0	160.5	4.0	110	362	301
8	200	201.3	217.0	200.2	4.6	160	416	350

REVERSE Y

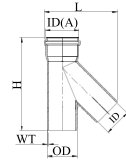

Size (in)	Size (mm)	Socket ID	Groove ID (A)	Spigot OD	WT	H	L
2½	75	76.2	84.5	75.3	3.2	236	172

SINGLE Y

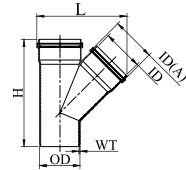

Size (in)	Size (mm)	Socket ID	Groove ID (A)	Spigot OD	WT	H	L
2½	75	76.2	84.5	75.3	3.2	220	174
3	90	91.2	100.5	90.3	3.2	261	206
4	110	111.3	121.3	110.4	3.2	303	248
6	160	161.5	175.0	160.5	4.0	422	326
8	200	201.3	217.0	200.2	4.6	490	450

DOUBLE TEE

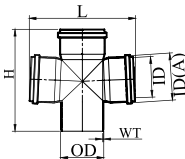

Size (in)	Size (mm)	Socket ID	Groove ID (A)	Spigot OD	WT	H	L
2½	75	76.2	84.5	75.3	3.2	193	193
3	90	91.2	100.5	90.3	3.2	227	233
4	110	111.3	121.3	110.4	3.2	262	269

DOOR Y

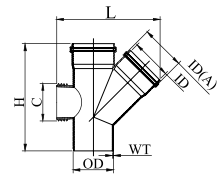

Size (in)	Size (mm)	Socket ID	Groove ID (A)	Spigot OD	WT	C	H	L
2½	75	76.2	84.5	75.3	3.2	75	220	191
3	90	91.2	100.5	90.3	3.2	90	261	225
4	110	111.3	121.3	110.4	3.2	110	303	230
6	160	161.5	175.0	160.5	4.0	110	422	370
8	200	201.3	217.0	200.2	4.6	160	490	495

DOUBLE DOOR TEE

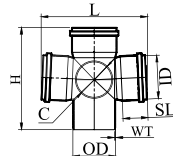

Size (in)	Size (mm)	Socket ID	Groove ID (A)	Spigot OD	WT	C	H	L
2½	75	76.2	84.5	75.3	3.2	75	193	193
3	90	91.2	100.5	90.3	3.2	90	227	233
4	110	111.3	121.3	110.4	3.2	110	262	265

DOUBLE Y

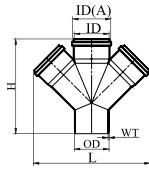

Size (in)	Size (mm)	Socket ID	Groove ID (A)	Spigot OD	WT	H	L
2½	75	76.2	84.5	75.3	3.2	250	261
3	90	91.2	100.5	90.3	3.2	261	312
4	110	111.3	121.3	110.4	3.2	303	337
6	160	161.5	175.0	160.5	4.0	490	630

DOUBLE DOOR Y

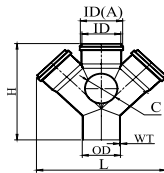

Size (in)	Size (mm)	Socket ID	Groove ID (A)	Spigot OD	WT	C	H	L
2½	75	76.2	84.5	75.3	3.2	80	250	261
3	90	91.2	100.5	90.3	3.2	90	261	312
4	110	111.3	121.3	110.4	3.2	110	303	337
6	160	161.5	175.0	160.5	4.0	110	490	630

LEFT SIDE DOOR ELBOW

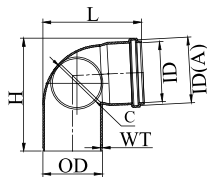

Size (in)	Size (mm)	Socket ID	Groove ID (A)	Spigot OD	WT	C	H	L
4	110	111.3	121.3	110.4	3.2	110	228	208

RIGHT SIDE DOOR ELBOW

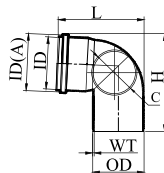

Size (in)	Size (mm)	Socket ID	Groove ID (A)	Spigot OD	WT	C	H	L
4	110	111.3	121.3	110.4	3.2	110	228	208

LEFT SIDE DOOR TEE

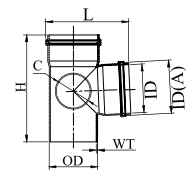

Size (in)	Size (mm)	Socket ID	Groove ID (A)	Spigot OD	WT	C	H	L
4	110	111.3	121.3	110.4	3.2	110	263	195

RIGHT SIDE DOOR TEE

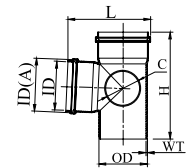

Size (in)	Size (mm)	Socket ID	Groove ID (A)	Spigot OD	WT	C	H	L
4	110	111.3	121.3	110.4	3.2	110	263	195

SWEPT TEE PLAIN

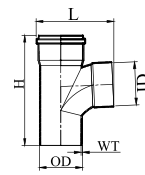

Size (in)	Size (mm)	Socket ID	Groove ID (A)	Spigot OD	WT	H	L
4	110	111.3	121.3	110.4	3.2	282	195

SWEPT TEE WITH DOOR

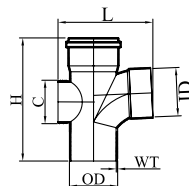

Size (in)	Size (mm)	Socket ID	Groove ID (A)	Spigot OD	WT	C	H	L
4	110	111.3	121.3	110.4	3.2	110	282	223

LONG SWEPT TEE

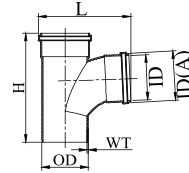

Size (in)	Size (mm)	Socket ID	Groove ID (A)	Spigot OD	WT	H	L
4	110	111.3	121.3	110.4	3.2	285	226
6	116	161.5	175.0	160.5	4.0	397	317
8	200	201.3	217.0	200.2	4.6	497	396

LONG SWEPT TEE WITH DOOR

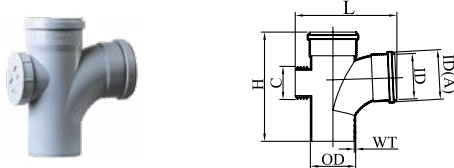

Size (in)	Size (mm)	Socket ID	Groove ID (A)	Spigot OD	WT	C	H	L
4	110	111.30	121.0	111.4	3.2	110	285	245
6	160	161.5	175.0	160.5	4.0	110	397	335
8	200	201.3	217.0	200.2	4.6	160	497	420

BACKFLOW PREVENTER

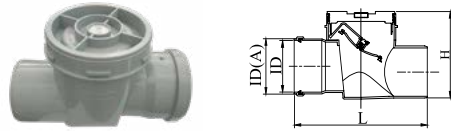

Size (in)	Size (mm)	Socket ID	Groove ID (A)	H	L
4	110	111.30	121.3	170	280
6	160	161.5	175.0	257	396

SWEPT TEE TRIPLE SOCKET (T)

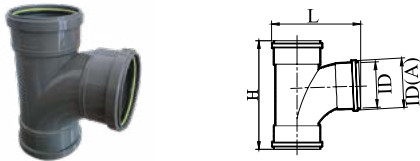

Size (in)	Size (mm)	Socket ID	Groove ID (A)	WT	H	L
4	110	111.3	121.3	3.2	285	250



Size (in)	Size (mm)	Socket ID	H	L
2½	75	76.2	185	735
3	90	91.2	222	893
4	110	111.3	225	880

LONG SWEPT BEND

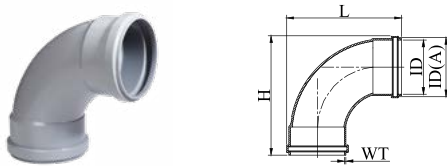

Size (in)	Size (mm)	Socket ID	Groove ID (A)	WT	H	L
4	110	111.3	121.3	3.2	230	226
6	160	161.5	175.0	4.0	323	317
8	200	201.3	217.0	4.6	405	397

RUBBER WASHER

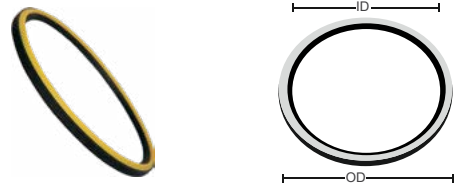

Size (in)	Size (mm)	ID	OD
2½	75	76.2	85.01
3	90	91.2	100
4	110	111.3	121.5
6	160	161.5	174.14
8	200	193.3	215.5
10	250	239.6	272.8
12	315	303	341.0

LONG SWEPT BEND WITH DOOR

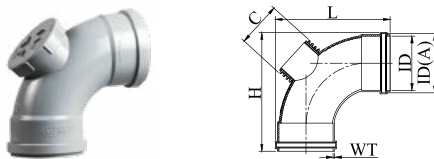

Size (in)	Size (mm)	Socket ID	Groove ID (A)	WT	C	H	L
4	110	111.3	121.3	3.2	110	230	226
6	160	161.5	175.0	4.0	110	323	317
8	200	201.3	217.0	4.6	110	405	397

RUBBER LUBRICANTS



Weight in Grams	Container Type
100	Can
250	Can
500	Can

REDUCING TEE

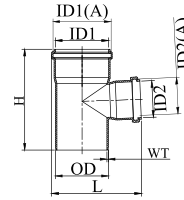

Size (in)	Size (mm)	Groove ID 1 (A)	Groove ID 2 (A)	Socket ID-1	Socket ID-2	WT	H	L
3x2½	90x75	100.5	84.5	91.2	76.2	3.2	228	158
4x2½	110x75	121.3	84.5	111.3	76.2	3.2	262	181
6x2½	160x75	175.0	85.5	161.5	76.2	4.0	362	338
6x4	160x110	175.0	121.3	160.1	111.3	4.0	363	249

REDUCING DOOR TEE

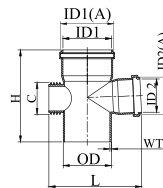

Size (in)	Size (mm)	Groove ID 1 (A)	Groove ID 2 (A)	Socket ID-1	Socket ID-2	WT	C	H	L
3x2½	90x75	100.5	84.5	91.2	76.2	3.2	90	228	189
4x2½	110x75	121.3	84.5	111.3	76.2	3.2	110	262	210
6x2½	160x75	175.0	85.5	161.5	76.2	4.0	110	362	363
6x4	160x110	175.0	121.3	160.1	111.3	4.0	110	362	277

REDUCING Y

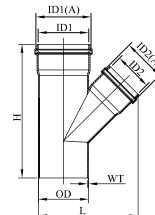

Size (in)	Size (mm)	Socket ID-1	Socket ID-2	Spigot OD	Groove ID 1 (A)	Groove ID 2 (A)	WT	H	L
4x2½	110x75	111.3	76.2	110.4	121.3	84.5	3.2	284	212
6x4	160x110	161.5	111.3	161.5	175.0	121.3	4.0	430	420

REDUCING DOOR Y

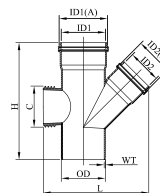

Size (in)	Size (mm)	Socket ID-1	Socket ID-2	Spigot OD	Groove ID 1 (A)	Groove ID 2 (A)	WT	C	H	L
4x2½	110x75	111.3	76.2	110.4	121.3	84.5	3.2	110	284	229
6x4	160x110	161.5	111.3	161.5	175.0	121.3	4.0	160	430	438

SINGLE STACK

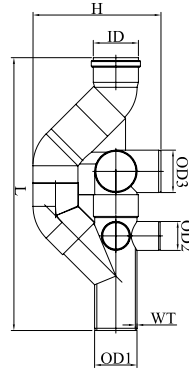

Size (in)	Size (mm)	ID	OD 1	OD 2	OD 3	H	L	WT
4	110	111.3	110.4	75.3	110.4	332	708	3.2

SINGLE STACK SWR SYSTEMS

A single stack soil and waste system offering the possibility to connect multiple toilets. The main advantages of the Ashirvad SWR single stack fitting being: space saving, higher flow capacity of stack, less installed cost (PVC pipe system with low weight, elimination of vent pipe and its connections) and reduced hydraulic pressure.

Product Dimensions: Solfit Fittings

PLAIN BEND

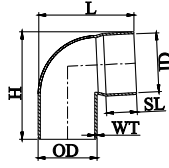

Size (in)	Size (mm)	Socket ID	Spigot OD	SL	WT	H	L
2½	75	76.2	75.3	40	3.2	166	130
3	90	91.2	90.3	46	3.2	195	150
4	110	111.3	110.4	48	3.2	178	170
6	160	161.5	160.5	58	4.0	248	230

1½	50	51.1	2.9	50	66
2	63	63.1	3.0	70	80
2½	75	76.2	3.2	75	85
3	90	91.2	3.2	99	99
4	110	111.3	3.2	120	102
5	140	140.6	3.6	148	138
6	160	161.5	4.0	170	152
8	200	200.6	4.6	210	219
10	250	250.8	5.7	262	271
12	315	316.0	7.2	331	338

DOOR BEND

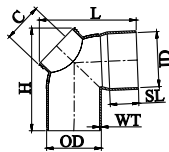

Size (in)	Size (mm)	Socket ID	Spigot OD	SL	WT	H	L
2½	75	76.2	75.3	40	3.2	133	153
3	90	91.2	90.3	46	3.2	165	167
4	110	111.3	110.4	48	3.2	189	190
6	160	161.5	160.5	58	4.0	248	244

HEAVY COUPLER

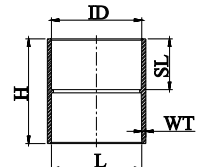

Size (in)	Size (mm)	ID	WT	H	L
2½	75	76.2	3.2	101	85
4	110	111.3	3.2	129	102

BEND 45°

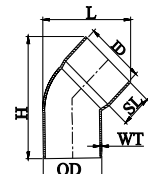

Size (in)	Size (mm)	Socket ID	Spigot OD	SL	WT	H	L
2½	75	76.2	75.3	40	3.2	146	110
3	90	91.2	90.3	46	3.2	167	130
4	110	111.3	110.4	48	3.2	186	156
6	160	161.5	160.5	58	4.0	253	199

SINGLE TEE

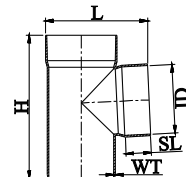

Size (in)	Size (mm)	ID	SL	WT	H	L
2½	75	76.2	40	3.2	180	133
3	90	91.2	46	3.2	209	156
4	110	111.3	48	3.2	232	175
5	140	140.2	54	3.6	280	240
6	160	161.5	58	4.0	319	250

COUPLER

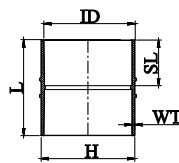

Size (in)	Size (mm)	ID	WT	H	L
1¼	40	40.1	2.9	40	55

DOOR TEE

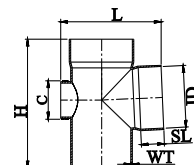

Size (in)	Size (mm)	Socket ID	SL	WT	C	H	L
-----------	-----------	-----------	----	----	---	---	---

2½	75	76.20	40	3.2	75	180	156
3	90	90.21	46	3.2	90	209	178
4	110	111.30	48	3.2	232	232	203
6	160	161.50	58	4.0	319	319	267

DOUBLE TEE

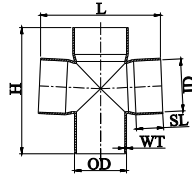

Size (in)	Size (mm)	ID	Spigot OD	SL	WT	H	L
2½	75	76.2	75.3	40	3.20	180	182
3	90	91.2	90.3	46	3.20	209	222
4	110	111.3	110.3	48	3.20	232	234

DOUBLE DOOR TEE

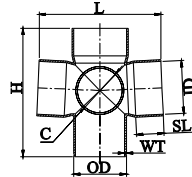

Size (in)	Size (mm)	Socket ID	Spigot OD	SL	WT	C	H	L
2½	75	76.2	75.3	40	3.2	75	180	182
3	90	91.2	90.3	46	3.2	90	209	222
4	110	111.3	110.3	48	3.2	110	232	234

SINGLE Y

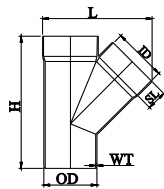

Size (in)	Size (mm)	Socket ID	Spigot OD	SL	WT	H	L
2½	75	76.2	75.3	40	3.2	208	170
3	90	91.2	90.3	46	3.2	241	198
4	110	111.3	110.4	48	3.2	276	235
6	160	161.5	160.5	58	3.6	380	330

DOOR Y

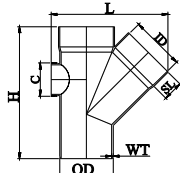

Size (in)	Size (mm)	Socket ID	Spigot OD	SL	WT	C	H	L
2½	75	76.2	75.3	40	3.2	75	208	195

3	90	91.2	90.3	46	3.2	90	241	225
4	110	111.3	110.4	48	3.2	110	276	271
6	160	161.5	160.5	58	3.6	160	380	362

DOUBLE Y

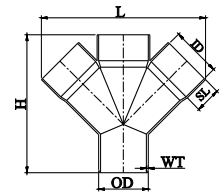

Size (in)	Size (mm)	Socket ID	Spigot OD	SL	WT	H	L
2½	75	76.2	75.3	40	3.2	207	250
3	90	91.2	90.3	46	3.2	241	300
4	110	111.3	110.4	48	3.2	274	359

DOUBLE DOOR Y

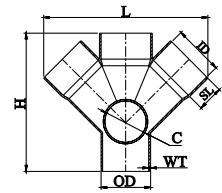

Size (in)	Size (mm)	Socket ID	Spigot OD	SL	WT	C	H	L
2½	75	76.2	75.3	40	3.2	75	207	250
3	90	91.2	90.3	46	3.2	90	241	300
4	110	111.3	110.4	48	3.2	110	274	359

CLEANING PIPE

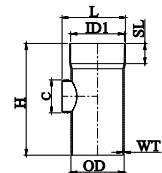

Size (in)	Size (mm)	Socket ID	Spigot OD	SL	WT	C	H	L
2½	75	76.2	75.3	40	3.20	75	180	116
3	90	91.2	90.3	46	3.20	90	210	131
4	110	111.3	110.4	48	3.20	110	232	153
6	160	161.5	160.5	58	3.60	160	363	200

REDUCER OFFSET

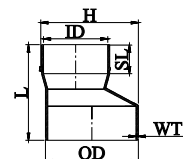

Size (in)	Size (mm)	ID	OD	SL	WT	H	L
4x2½	110x75	76.2	110.4	40	3.2	82	137
6x4	160x110	111.3	160.5	48	4.0	118	155

REDUCING TEE

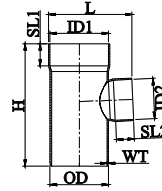

Size (in)	Size (mm)	ID-1	ID-2	Spigot OD	SL-1	SL-2	WT	H	L
3x2½	90x75	91.2	76.2	90.3	46	40	3.2	228	150
4x2½	110x75	111.3	76.2	110.3	48	40	3.2	232	168
6x4	160x110	161.5	111.3	160.3	58	48	4.0	319	227

REDUCING DOOR TEE

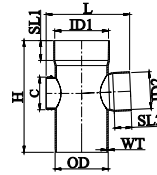

Size (in)	Size (mm)	ID-1	ID-2	Spigot OD	SL-1	SL-2	WT	C	H	L
3x2½	90x75	91.2	76.2	90.3	46	40	3.2	90	210	182
4x2½	110x75	111.3	76.2	110.3	48	40	3.2	110	232	207
6x4	160x110	161.5	110.1	160.3	58	48	4.0	110	320	265

REDUCING Y

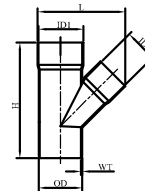

Size (in)	Size (mm)	Socket ID-1	Socket ID-2	Spigot OD	WT	H	L
4x2½	110x75	110.38	75.30	110.22	3.2	250	175
6x4	160x110	-	-	-	-	-	-

REDUCING DOOR Y

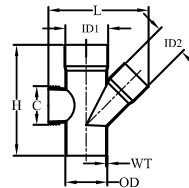

Size (in)	Size (mm)	Socket ID-1	Socket ID-2	Spigot OD	WT	C	H	L
4x2½	110x75	110.38	75.30	110.22	3.2	110	250	203
6x4	160x110	-	-	-	-	-	-	-

SINGLE STACK

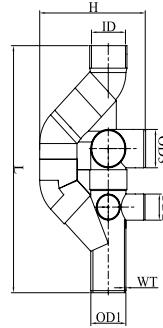

Size (in)	Size (mm)	ID	OD 1	OD 2	OD 3	H	L	WT
4	110	111.3	110.4	75.3	110.4	332	708	3.2

SINGLE STACK SWR SYSTEMS

A single stack soil and waste system offering the possibility to connect multiple toilets. The main advantages of the Ashirvad SWR single stack fitting being: space saving, higher flow capacity of stack, less installed cost (PVC pipe system with low weight, elimination of vent pipe and its connections) and reduced hydraulic pressure.

REPAIR COUPLER

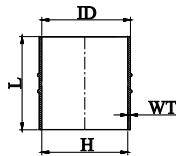

Size (in)	Size (mm)	ID	WT	H	L
2½	75	76.2	3.2	84	76
3	90	91.2	3.2	100	89
4	110	111.3	3.2	119	102
6	160	160.1	4.0	172	126

8x6	200x160	200.6	160.5	106	58	4.6	222	210
10x8	250x200	250.8	200.6	131	106	5.7	272	265
12x8	315x250	316.0	250.8	163.5	131	7.2	314	316

REDUCING BUSH

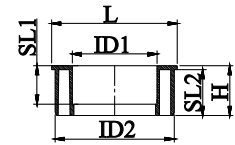

Size (in)	Size (mm)	ID-1	ID-2	SL-1	SL-2	H	L
1½x¼	50x40	51.1	40.1	30	26	35	59
2x1½	63x50	63.1	51.1	36	30	41	72
2½x¼	75x40	75.1	40.3	40	26	43	84
2½x1½	75x50	75.1	50.4	40	32	43	84
2½x2	75x63	76.2	63.1	40	36	44	84
3x2½	90x75	91.2	76.2	46	40	51	96
4x2½	110x75	111.3	76.2	48	40	52	117
4x3	110x90	111.3	91.2	48	46	53	117
5x4	140x110	140	110	54	55	70	147
6x4	160x110	160.1	111.3	58	46	65	167

REDUCER COUPLER

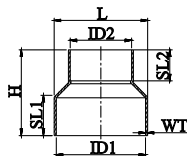

Size (in)	Size (mm)	ID-1	ID-2	SL-1	SL-2	WT	H	L
2x1½	63x50	63.1	51.1	36	30	3	80	70
2½x1½	75x50	76.2	51.1	40	30	3.2	85	75
2½x2	75x63	76.2	63.1	40	36	3.2	93	75
4x2½	110x75	110.4	75.3	48	41	3.2	120	117
4x3	110x90	110.4	90.3	48	48	3.2	125	117
5x4	140x110	140.0	110.4	54	55	3.2	139	148
6x4	160x110	160.5	110.4	58	55	4.0	162	168

PASS OVER BEND (TYPE B - PIPES)

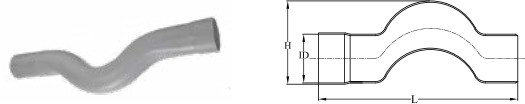

Size (in)	Size (mm)	ID	H	L
2½	75	76.20	185	775
3	90	91.2	222	893
4	110	111.3	225	880

SWEPT TEE PLAIN

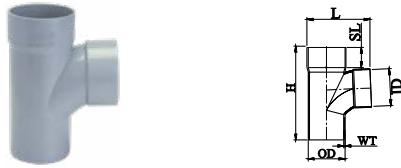

Size (in)	Size (mm)	Socket ID	Spigot OD	SL	WT	H	L
4	110	111.30	110.40	48	3.20	267	195

SWEEP TEE WITH DOOR

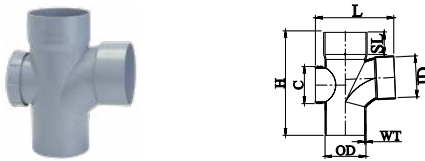

Size (in)	Size (mm)	Socket ID	Spigot OD	SL	WT	C	H	L
4	110	111.3	110.4	48	3.2	110	267	226

Solvent Adhesive



Weight in Litres

Container Type

100 ml	Can
250 ml	Can
500 ml	Can
1000 ml	Can

Product Dimensions: Equal Solfit Fittings

EQUAL ELBOW

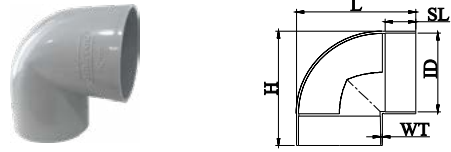

Size (in)	Size (mm)	ID	SL	WT	H	L
1¼	40	40.1	26.0	2.9	71	71
1½	50	51.1	31.8	2.9	87	84
2	63	63.1	38.2	3.0	108	107
2½	75	76.2	40	3.2	123	130
3	90	91.2	46	3.2	144	150
4	110	111.3	48	3.2	171	170
5	140	140.2	58	3.2	212	212
6	160	160.5	67.5	3.6	240	240
8	200	200.6	107	4.6	320	320

EQUAL ELBOW WITH DOOR

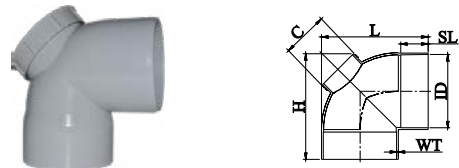

Size (in)	Size (mm)	ID	WT	SL	C	H	L
1½	50	51.1	2.9	31.8	50	87	84
2	63	63.1	3.0	38.2	63	108	107
2½	75	76.2	3.2	40	75	123	130
3	90	91.2	3.2	46	90	163	163
4	110	111.3	3.2	48	110	171	170
5	140	140.2	3.2	58	110	228	203
6	160	160.5	3.6	67.5	110	240	240

EQUAL BEND 45°

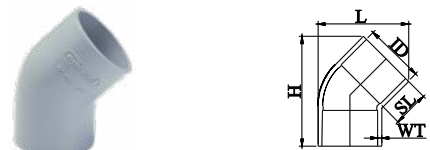

Size (in)	Size (mm)	ID	WT	SL	H	L
1¼	40	40.1	2.9	26	80	65



The following notation (symbols) shall apply in this reference manual.

L - Length
W - Width
H - Height

T - Thickness
U - No. of holes
SL - Socket Length

ID - Inner Diameter
OD - Outer Diameter
WT - Wall Thickness

1½	50	51.1	2.9	31.8	96	79
2	63	63.1	3.0	38.2	117	97
2½	75	75.4	3.0	40	114	113
3	90	90.4	3.0	46	157	133
4	110	110.4	3.2	48	186	160
5	140	140.6	3.2	58	223	196
6	160	160.5	3.6	67.5	246	220

EQUAL TEE

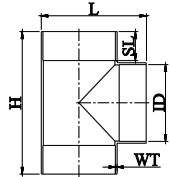

Size (in) Size (mm) ID SL WT H L

1¼	40	40.1	26	2.9	97	72
1½	50	51.1	31.8	2.9	119	87
2	63	63.1	38.2	3.0	144	107
2½	75	76.2	40	3.2	165	125
3	90	91.2	46	3.2	195	145
4	110	111.3	48	3.2	227	170
5	140	140.2	58	3.2	279	245
6	160	160.5	67.5	3.6	313	239
8	200	200.6	107	4.6	430	320

EQUAL TEE WITH DOOR

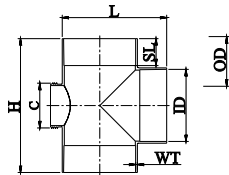

Size (in) Size (mm) ID SL WT C H L

1½	50	51.1	31.8	2.9	50	118	107
2	63	63.1	38.2	3.0	63	144	131
2½	75	76.2	40	3.2	75	166	156
3	90	91.2	46	3.2	90	195	179
4	110	111.3	48	3.2	110	227	207
5	140	140.2	58	3.2	110	278	247
6	160	160.5	67.5	3.6	110	313	265

EQUAL REDUCER TEE

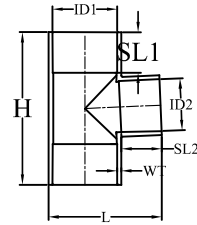

Size (in) Size (mm) ID-1 ID-2 SL-1 SL-2 WT H L

2½x1¼	75x40	75.3	40.3	40	26	3.0	166	112
2½x1½	75x50	75.3	50.3	40	31.8	3.0	166	115
2½x2	75x63	75.3	63.3	40	38.2	3.0	166	118
4x1¼	110x40	110.41	40.3	48	26	3.8	227	165
4x1½	110x50	110.4	50.3	48	31.8	3.8	227	168
4x2	110x63	110.4	63.3	48	38.2	3.8	227	174
4x2½	110x75	110.4	75.3	48	40	3.8	227	178
4x3	110x90	110.4	90.3	48	46	3.8	227	184

EQUAL REDUCER DOOR TEE

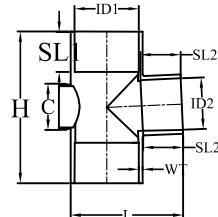

Size (in) Size (mm) ID-1 ID-2 SL-1 SL-2 WT C H L

2½x1¼	75x40	75.3	40.3	40	26	3.0	75	166	112
2½x1½	75x50	75.3	50.3	40	31.8	3.0	75	166	115
2½x2	75x63	75.3	63.3	40	38.2	3.0	75	166	118
4x1¼	110x40	110.41	40.3	48	26	3.8	110	227	165
4x1½	110x50	110.4	50.3	48	31.8	3.8	110	227	168
4x2	110x63	110.4	63.3	48	38.2	3.8	110	227	174
4x2½	110x75	110.4	75.3	48	40	3.8	110	227	178
4x3	110x90	110.4	90.3	48	46	3.8	110	227	184

EQUAL Y

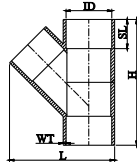

Size (in)	Size (mm)	Socket ID	SL	WT	H	L
1¼	40	40.3	26.0	3.0	113	95
1½	50	50.3	31.8	3.0	138	115
2	63	63.4	38.2	3.0	170	140

EQUAL Y WITH DOOR

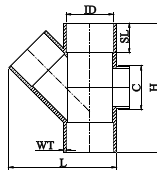

Size (in)	Size (mm)	Socket ID	C	SL	WT	H	L
1½	50	50.3	50	31.8	3.0	138	129
2	63	63.4	63	38.2	3.0	170	162

Q TRAP

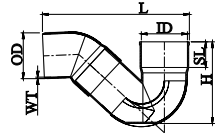

Size (in)	Size (mm)	Socket ID	Socket Length	Spigot OD	WT	H	L
4x4	110x110	110.4	48	110.3	3.2	217	395
4x4½	110x125	110.4	48	125.3	3.2	219	400

S TRAP

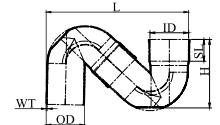

Size (in)	Size (mm)	Socket ID	Socket Length	Spigot OD	WT	H	L
4x4	110x110	110.4	48	110.3	3.2	217	395
4x4½	110x125	110.4	48	125.3	3.2	219	400

Product Dimensions: Common Fittings

BELL MOUTH TRAP

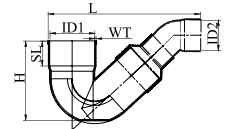

Size (in)	Size (mm)	Socket ID 1	Socket ID 2	Socket Length	WT	H	L
4x2½ (P/F)	110x75	110.4	75.3	48	3.2	250	387
4x2½ (S/F)	110x75	110.4	75.3	48	3.2	240	375

P TRAP

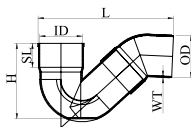

Size (in)	Size (mm)	Socket ID	SL	Spigot OD	WT	H	L
2½X2½	75	75.3	40	75.3	3.2	168	250
3X3	90x90 (with leg)	90.5	52	90	3.2	180	289
3X3	90x90 (with out leg)	90.5	52	90	3.2	160	289
4x4 (short)	110x110 (short)	110.4	48	110.3	3.2	192	312
4x4 (long)	110x110 (long)	110.4	48	110.3	3.2	219	360
4x4½	110x125 (long)	110.4	48	125.3	3.2	218	366

FLOOR TRAP

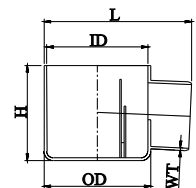

Size (in)	Size (mm)	ID	Spigot OD	WT	H	L
4x2	110x63	110.4	63.3	3.2	104	161
4x2½	110x75	110.4	75.3	3.2	104	160

NAHANI TRAP WITHOUT JALI

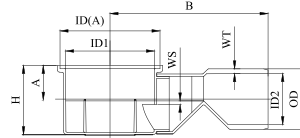

Size (in)	Size (mm)	ID (A)	Socket ID 1	Spigot OD	Spigot OD 2	WS	A	B	WT	H
1½ x1½	50x50	75.3	87	50	-	10	29.5	119	2.5	59
2x2 (3" ht)	63x63	100	85.60	63.27	-	9	31.5	144.25	2.4	63
3x3 (3" ht)	90x90	105	90.40	90.20	-	9	50	158.25	3.2	100
4x2 (3" ht)	110x63	124.4	110.38	-	63.25	9	42.75	198	-	85.5
4x2½ (3" ht)	110x75	124.4	110.38	75.18	-	9	42.75	199	3.2	85.5
4x3 (3" ht)	110x90	124.4	110.38	90.20	-	9	42.75	199.5	3.2	85.5
4x4 (3" ht)	110x110	124.4	110.38	-	110.3	9	42.75	217.0	-	85.5
4x2½ (5" ht)	110x75	124.4	110.40	75.18	-	9	62.25	191.75	3.2	124.5
4x3 (5" ht)	110x90	124.4	110.40	90.20	-	9	62.25	198.25	3.2	124.5
4x4 (5" ht)	110x110	124.4	110.40	-	110.3	9	62.25	216.75	-	124.5

MULTI TRAP WITHOUT JALI

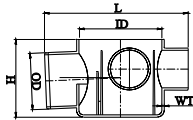

Size (in)	Size (mm)	ID	Spigot OD	WT	H	L
4 (4" HT)	110	110.4	75.19	3.2	104	191
4 (7" HT)	110	110.4	75.17	3.2	178	211

Size (in)	Size (mm)	Socket ID	Socket Length	H	L
4	110	110.4	48	239	287

GULLY TRAP WITHOUT JALI

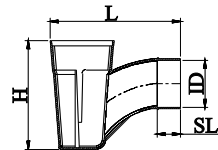

Size (in)	Size (mm)	Socket ID	Socket Length	H	L
4	110	110.4	48	239	287

MULTI TRAP WITH FOUL ARRESTOR

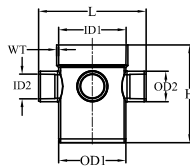

Size (in)	Size (mm)	ID	Spigot OD-1	Spigot OD-2	WT	H	L
4 (7" HT)	110	110.4	75.20	50.20	3.2	177	208

END CAP

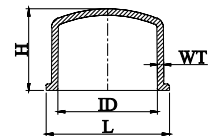

Size (in)	Size (mm)	ID	WT	H	L
1¼	40	40.3	-	35	51
1½	50	50.3	-	42	63
2	63	63.3	3.0	47	74
2½	75	75.3	3.2	54	87
3	90	90.3	3.2	63	102
4	110	110.4	3.2	68	126
6	160	160.5	4.0	107	176

GULLY TRAP WITH JALI

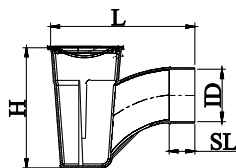

SOCKET PLUG

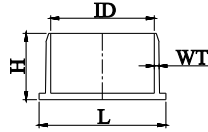

Size (in)	Size (mm)	ID	WT	H	L
1¼	40	40.3	-	27	46
1½	50	50.3	-	30	56
2	63	63.3	3.0	38	76
2½	75	75.3	3.2	48	96
3	90	90.3	3.2	48	105
4	110	110.4	3.2	58	130
6	160	160.5	4.0	66	174

Size (in)	Size (mm)	ID	WT	H	L
2½	75	75.3	3.2	74	80
3	90	90.3	3.2	85	95
4	110	110.4	3.2	92	116
6	160	160.3	3.6	131	166

DOOR CAP

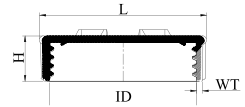

Size (in)	Size (mm)	ID	WT	H	L
1½	50	50.3	2.62	19	56
2	63	63.3	2.32	22	65
2½	75	75.3	3.2	25	79
3	90	90.3	3.2	24	93
4	110	110.4	3.2	28	110
6	160	134.0	3.2	30.5	145

PIPE CLIP - SMALL HOLES

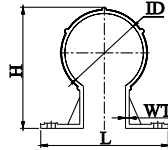

Size (in)	Size (mm)	ID	WT	H	L
2½	75	75.3	3.2	115	121
3	90	90.3	3.2	126	137
4	110	110.4	3.2	151	150
6	160	160.5	4.0	201	209

ROUND JALI

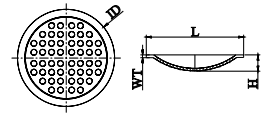

Size (in)	Size (mm)	ID	WT	H	L
1½	50	50.26	2.50	13	86
2	63	63.3	2.85	16	99
3	90	104.20	2.50	17	104.2
4	110	110.4	3.61	21	120

PIPE CLIP - BIG HOLES

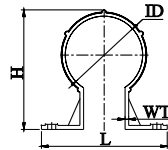

Size (in)	Size (mm)	ID	WT	H	L
2½	75	75.3	3.2	115	121
3	90	90.3	3.2	126	137
4	110	110.4	3.2	151	150
6	160	160.5	4.0	201	209

VENT COWL

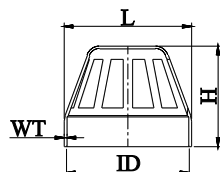

SQUARE JALI

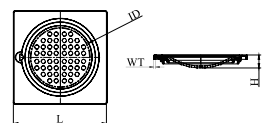

The following notation (symbols) shall apply in this reference manual.

L - Length
W - Width
H - Height

T - Thickness
U - No. of holes
SL - Socket Length

ID - Inner Diameter
OD - Outer Diameter
WT - Wall Thickness

Size (in)	Size (mm)	ID	WT	H	L
6 x 6	160 x 160	160.50	2.34	21	151

LIP RING

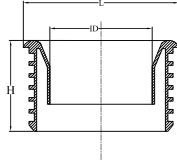

Size (in)	Size (mm)	ID	H	L
4x4½	110x125	110.4	49	132

WC CONNECTOR (BEND)

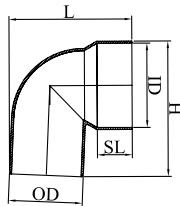

Size (in)	Size (mm)	ID	Spigot OD	Socket Length	H	L
4x4½	110x125	125.3	110.3	48	204	182

WC CONNECTOR (STRAIGHT)

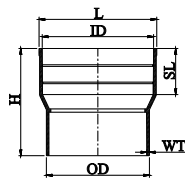

Size (in)	Size (mm)	ID	Spigot OD	Socket Length	WT	H	L
4x4½	110x125	110.3	125.3	48	3.2	120	133

ANTI SIPHON

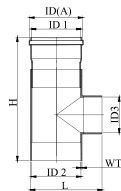

Size (in)	Size (mm)	ID-1	ID-2	ID-3	Groove ID(A)	WT	H	L
2½x1¼	75x40	76.2	76.20	40.25	84.50	3.2	268.2	127.3
2½x1½	75x50	76.2	76.20	50.26	84.50	3.2	268.2	125.0
2½x2	75x63	76.2	76.20	63.27	84.50	3.2	268.2	120.2
4x1¼	110x40	111.3	111.30	40.25	121.30	3.2	320.0	161.5
4x1½	110x50	111.3	111.30	50.26	121.30	3.2	320.0	165.0
4x2	110x63	111.3	111.30	63.27	121.30	3.2	320.0	161.0
4x2½	110x75	111.3	111.30	75.30	121.30	3.2	320.0	160.0
4x3	110x90	111.3	111.30	90.30	121.30	3.2	320.0	168.0

HEIGHT RISER WITH RING

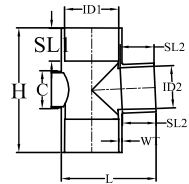

Size (in)	Size (mm)	ID-1	ID-2	OD-1	OD-2	WT	H	L
4x1½ x 1¼	110x50 x 40	110.4	40.25	110.22	50.26	3.2	160	176

HEIGHT RISER WITHOUT RING

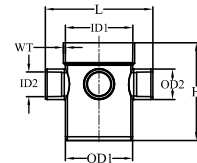

Size (in)	Size (mm)	ID-1	ID-2	OD-1	OD-2	WT	H	L
4x1½ x 1¼	110x50 x 40	110.4	40.2	110.22	50.26	3.2	160	176

THREADED END PLUG / CLEAN OUT PLUG

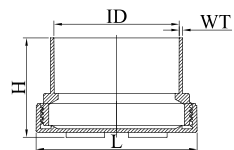

Size (in)	Size (mm)	ID	WT	L	H
2	63	63.4	3.0	79.6	71.85

2½	75	75.45	3.0	93.5	73.75
3	90	90.3	2.9	110.1	83.0
4	110	110.45	3.0	145.3	88.0
6	160	160.5	3.6	175	106

PIPE STACKER BASE



Size (in)	Size (mm)	ID	W	H	L
2½	75	75.3	20	161	1070
3	90	90.3	20	160	1065
4	110	110.4	20	161	1065
6	160	160.50	20	166	1065

PIPE STACKER



Size (in)	Size (mm)	ID	WT	H	L
2½	75	75.3	20	85	1070
3	90	90.3	20	100	1065
4	110	110.4	20	117	1065
6	160	160.5	20	166	1065

PIPE STACKER NYLON BUSH



Size (in)	Size (mm)	H	L
2½	75	136	52
3	90	135	50
4	110	135	50
6	160	139	66

PAN CONNECTOR - APCS2 - STRAIGHT

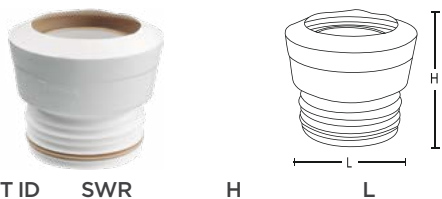

SPIGOT ID (mm)	SWR (mm)	H	L
97 - 108	99 - 105	108	137

PAN CONNECTOR - APC02 18 MM OFFSET

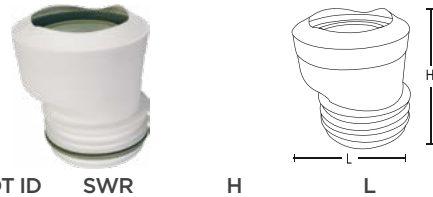

SPIGOT ID (mm)	SWR (mm)	H	L
97 - 108	99 - 105	128	144

PAN CONNECTOR - APC04 40 MM OFFSET

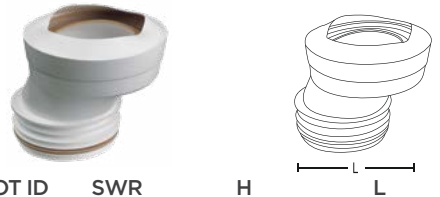

SPIGOT ID (mm)	SWR (mm)	H	L
97 - 108	99 - 105	142	164

PAN CONNECTOR - APCC2 - COLLAPSIBLE



SPIGOT ID (mm)	SWR (mm)	H	L
97 - 108	99 - 105	141	W/o expansion: 251 With expansion: 550

CORRUGATED WASTE PIPE (WHITE)



Size (in)	Size (mm)	OD	L
-	35	-	-
-	42	49.0	825
-	42 long	46.0	864

Other
Products in
SWR Portfolio

GREASE INTERCEPTORS

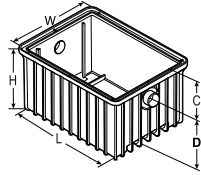

LPS /kgs	H (mm)	L (mm)	W (mm)	C (mm)	D (mm)
0.94/13.6	414	368	444	89	325
1.6/22.7	414	600	444	104	310
3.2/45.4	596.9	787	597	127	469.9
1.6/Low	279	787	597	102	178

SOLID INTERCEPTORS

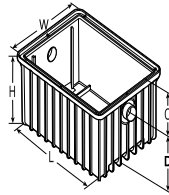

LPS /kgs	H (mm)	L (mm)	W (mm)	C (mm)	D (mm)
3.2/220	414	368	441	89	325

RISER FOR GREASE INTERCEPTORS

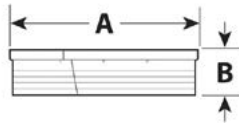

LPS /kgs	A (mm)	B (mm)	-	-	-
1.6/22.7	600	178	-	-	-
3.2/45.4	788	178	-	-	-

AIR ADMITTANCE VALVES

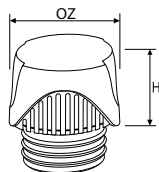

OZ	H (mm)	Vol Flow (litres/sec)	For DN
----	--------	-----------------------	--------

82	62	8	30
			40
			50
129	93	25	70
			90
			100

FILTER RELEASE VALVES

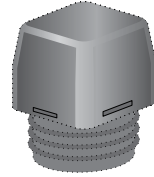

OZ	H (mm)	Vol Flow (litres/sec)	For DN
----	--------	-----------------------	--------

105	80	-	70
			90
			100

FIRE COLLAR AND ACRYLIC SEALANT



Length of Fire Collar (mm)	Volume of Sealant (ml)
----------------------------	------------------------

2250	300
------	-----

GUIDE OF COLLAR SIZES

Nominal pipe size		Casing Segments	Approx. Collars per box
mm	inch	Nos.	Nos.
43		15	10
50	1.5	17	8.5
55		18	8
63		20	7.5
-	2	19	7.5
69		21	7
75	2.5	22	6.5
83		24	6
90	3	25	6
110		29	5
114	4	30	5
125		33	4.5
140	5	36	4
160		40	3.75
-	6	42	3.5
200		49	3

Do's and Dont's

Do's

- Ashirvad Co-Molded Yellow Seal™ Technology (rubber ring) consists of 2 parts- rubber ring (black) which provides the seal tight joint and polymer (yellow) which acts as a retainer giving shape and strength to the ring. The ring will never fall off the groove when pipe/ fitting is inserted. Neither is it easy for the plumber to remove the ring by hand. The ring is made in our own factory and not imported. These rubber rings can be procured as spares.
- Always encourage the use of lubricant while inserting pipe/fitting. This makes the fitment very easy and the pipe/fitting simply slides inside without much effort. The joint can also be made without using lubricant but the same becomes much harder.
- The purpose of the lubricant is simply easy installation and is NOT a glue (note: do not confuse with Solvent).
- A joint made with or without the use of lubricant has the SAME pressure withstanding capacity/life/joint strength.
- The greasy property of the lubricant lasts only for a few hours in the joint, after which it will dry up.
- Ashirvad pushfit systems are tested to withstanding capacity of 5kg/cm².

Don'ts

- DON'T Try to remove rubber ring from pipe or fitting. (in Pushfit systems).
- DON'T Install pipe in pushfit fitting without rubber ring by trying to apply solvent and thinking it will become leak proof. THIS IS WRONG AND THE SYSTEM MAY FAIL.
- DON'T Mix ashirvad pipe/ fitting with products from other players as fitment may not match properly leading to leakages.
- DON'T Mix Pushfit fittings and Solfit pipes.
- DON'T Use solvent adhesive for Pushfit joints.
- DON'T Use lubricant for Solfit joints.
- DON'T Cut pipe and make socket by heating and bellowing pipe mouth (manually at site). Buy and use only company made socketed pipe for installation. Ashirvad has the complete range 2ft- 20ft.

Ashirvad SWR limited warranty

Ashirvad Pipes, Bengaluru warrants to the original owner that the product will be free from manufacturing defects and conform to the current applicable IS Standards under normal use. Buyer's remedy for breach of this warranty is limited to replacement of, or credit for, the defective product. This warranty excludes any expense for removal or reinstallation of any defective product and any other incidental, consequential or punitive damages.

The limited warranty will not apply if

1. Ashirvad products are used in combination with any other brand / make of pipes and fittings.
2. Ashirvad Lubricant is not used for Ashirvad Pushfit systems
3. Ashirvad SWR solvent adhesive is not used for Ashirvad Solfit systems.
4. The product is used for applications other than soil, waste and rain water plumbing.
5. The installation guide provided in the manual is not followed.
6. The systems are not warranted against any mechanical damage by nails, chisels, drilling etc.

Recommendations

1. Use Type A pipes for venting and rainwater applications.
2. Use Type B pipes for soil and waste discharge applications.
3. SWR pushfit and solfit systems can be used in both horizontal and vertical applications when adequate supports are provided.
4. Usage of Swept Tee is recommended when connecting a horizontal discharge line into a vertical stack.
5. For multi- storey buildings the single stack SWR fitting may be more economical.

TM & PATENT: Any unauthorized use, copying, manufacturing etc. of the similar product or technology of the invention protected will attract legal actions including, imprisonment or fine under relevant IP laws • Printed in 2020 • All rights reserved. No part of this publication may be copied, modified, reproduced in any material from (including photocopying or storing it in any medium by electronic means and whether or not transiently or incidentally to some other use of this publication) without the written permission of the copyright owner. Applications for the copyright owner's written permission to reproduce any part of this publication should be addressed to the copyright owner. **Warning:** The doing of an unauthorized act in relation to a copyright work may result in both a civil claim for damages and criminal prosecution. **Disclaimer:** Due care and diligence has been taken while editing and printing the book. Neither the author nor the publishers of the book hold any responsibility for any mistake that may have inadvertently crept in. Publishers shall not be liable for any direct, consequential, or incidental damages arising out of the use of the book. In case of binding mistake, misprints, or for missing pages etc. • Printed and bound in India. Moral Rights of the Author are asserted • The copyright owner reserves all rights and liberty to modify, change or alter the design drawings of the products as and when it deems appropriate and necessary without any prior notice to the users.

All rights reserved copyright © 2020 Ashirvad Pipes Private Limited

Ashirvad Pipes Pvt. Ltd., 4-B, Attibele Industrial Area, Hosur Road, Bengaluru - 562 107, Karnataka, INDIA.

T: +91 80 2806 1000 / 2806 1700 **F:** +91 80 2806 1080

For any Service / Customer complaint / Queries:

Toll Free: 1800 572 8900 **M:** +91 9902 333 333 **E:** customercare@ashirvad.com

SMART WATER MANAGEMENT PLUMBING . SANITARY . AGRICULTURE



by **aliaxis**



www.ashirvad.com